



Toll Free: (866) 5ATM-INC
Main Office: (248) 932-5400
24/7 Technical Support: (866) 638-5918
Fax: (248) 932-5404

Hyosung 2100-T Manual

Table of Contents

1. Introduction

1.1 About NH 2100T	1-2
1.2 Features	1-2
1.3 What is in this Manual	1-3
1.4 Terminologies	1-4

2. Safety Precautions

2.1 Overview	2-2
2.2 Description of Precaution Symbols	2-3

3. Hardware Specifications

3.1 Dimensions	3-2
3.2 Component Name and Locations	3-3
3.3 LCD & Customer Keypad	3-5
3.4 CDU (Cash Dispensing Unit)	3-6
3.5 SPR (Slip Printer/Receipt Printer)	3-7
3.6 MCU (Magnetic Card Unit)	3-8
3.7 Main Control Board	3-9
3.8 Operating Environment	3-10

4. Operating Instructions

4.1 Opening and Closing the Doors	4-2
4.2 Replenishing the Cash Cassette	4-4
4.3 Emptying the Reject Box	4-6
4.4 Removing Bills	4-7
4.5 Loading the Receipt Paper	4-9
4.6 Receipt(Slip) Paper Jam Removal	4-11

5. Operator Functions

5.1 Basic System Operation	5-2
5.2 Settlement	5-5
5.3 Journal	5-11
5.4 Report	5-19
5.5 Diagnostics	5-27
5.6 Customer Setup	5-39
5.7 System Setup	5-50
5.8 Host Setup	5-70
5.9 Transaction Setup	5-94

6. Appendix

A. Summary of Specification	6-2
B. Bill Conditions	6-3
C. Receipt Paper Specifications	6-8
D. Magnetic Card Specifications	6-9
E. Error Codes Table	6-10

Chapter 1. Introduction

1. Introduction

1.1 About the NH 2100T

The NH 2100T (Through-The-Wall Type) is designed to meet the higher transaction volumes and the low maintenance components. Whether installed as a walk-up or drive-through, NH 2100T offers solid, weatherized construction while its compact architecture allows flexibility in mounting. The NH 2100T is easy to use, easy to service and is able to support customer's needs.

1.2 Features

H/W Features

- UL 291 Business Hours Vault
- Electronic combination lock
- 5.7" mono trans-flective LCD (sun-viewable)
- 16-key alphanumeric keypad (Encrypting PIN Pad)
- 2,000 notes capacity Cash Dispenser(CDU)
- Dip type magnetic card reader
- Semi-automated receipt paper loading and cutting
- 56K modem for dial-up
- Voice guidance system
- Modular design for easy maintenance

Functional Features

- Electronic journal
- Quick setup feature

1.3 What is in this manual

This NH 2100T Manual contains all information needed for normal operational use.

This manual contains Unit Specifications, Opening & Closing Procedures, Operator Functions(Supervisor Screen), Error Recovery, etc.

Some of the information in this manual may be subsequently updated based on the customer's needs or the improvement by Nautilus Hyosung.

1.4 Terminologies

CE : Control Electronics

Earphone Jack : Voice Converter for Visually Disabled Persons (ADA)

CDU : Cash Dispensing Unit

EPP : Encrypted PIN Pad

ISO: International Standard Organization

ISO 1: IATA(International Air Transaction Association)

ISO 2: ABA (American Banks Association)

ISO 3: MINTS (Mutual Institutions National Transfer Systems)

MCU : Magnetic Card Unit

OPL : Operator Panel (LCD Screen)

P/S : Power Supply

SPR : Slip Printer (Receipt Printer)

T-SPL : Supervisor Panel (LCD Screen)

Chapter 2. Safety Precautions

2. Safety Precautions

2.1 Overview

Common Safety Precaution



Safety Precautions outlined this manual provide information on safe and proper handling of the product. Non-compliance of the safety precautions may result in injury or damage to the product. This precaution symbol with sample term tells you safety warnings during equipment handlings.

Please read the following instructions before operating equipment.

- Operate equipment in the order outlined in this manual.
- Follow safety precautions indicated in this manual, as well as the equipment itself. Failure to properly address these precautions may lead to injury or damage to the product.
- Avoid operations not addressed in this manual.
- If you cannot remedy system problems using the methods outlined in this manual, please refer to contact information listed in the manual.

2.2 Description of Precaution Symbols

Symbol	Description
	<p>Electrical Shock Warning</p> <ul style="list-style-type: none"> • Do not remove cover. Only a maintenance engineer is allowed to open the cover. • Do not touch. You may receive electric shock. • Make sure to turn off the power when servicing the equipment.
	<p>High Temperature Warning</p> <ul style="list-style-type: none"> • Do not touch the equipment when it is running. • The equipment can get extremely hot and may cause a burn. • Make sure to close the cover before running the equipment.
	<p>Use Caution when Moving</p> <ul style="list-style-type: none"> • The equipment is heavy. Make sure at least 2 people lift or move the equipment. • Do not attempt to move the equipment alone. You may be injured from dropping the heavy equipment.
	<p>Fire Hazard</p> <ul style="list-style-type: none"> • Place the equipment in an area away from any combustible materials. • The equipment may catch on fire from overheating or short circuit of the power supply unit.
	<p>Disassembly Warnings</p> <ul style="list-style-type: none"> • Do not disassemble or modify the equipment unless you are a certified engineer. • Contact the service center for maintenance, adjustments and repairs. • Improper disassembly may cause fire or electrical shock.
	<p>Collapse Precautions</p> <ul style="list-style-type: none"> • Do not place the equipment where the floor cannot sustain the weight of the equipment, or on slanted or unstable surface. • Equipment may fall and cause injury or damage.

Symbol	Description
	<p>Unplug the Equipment</p> <ul style="list-style-type: none"> • Stop using the equipment immediately if it smokes, emits an unusual smell, makes abnormal sounds, or if liquids or other foreign materials enter the equipment. • If the above-mentioned abnormalities occur, immediately turn off the power, unplug the equipment and contact the service center. • If you ignore these symptoms, the equipment may catch on fire or cause electric shock.

Chapter 3. Hardware Specifications

3. Hardware Specifications

3.1 Dimensions

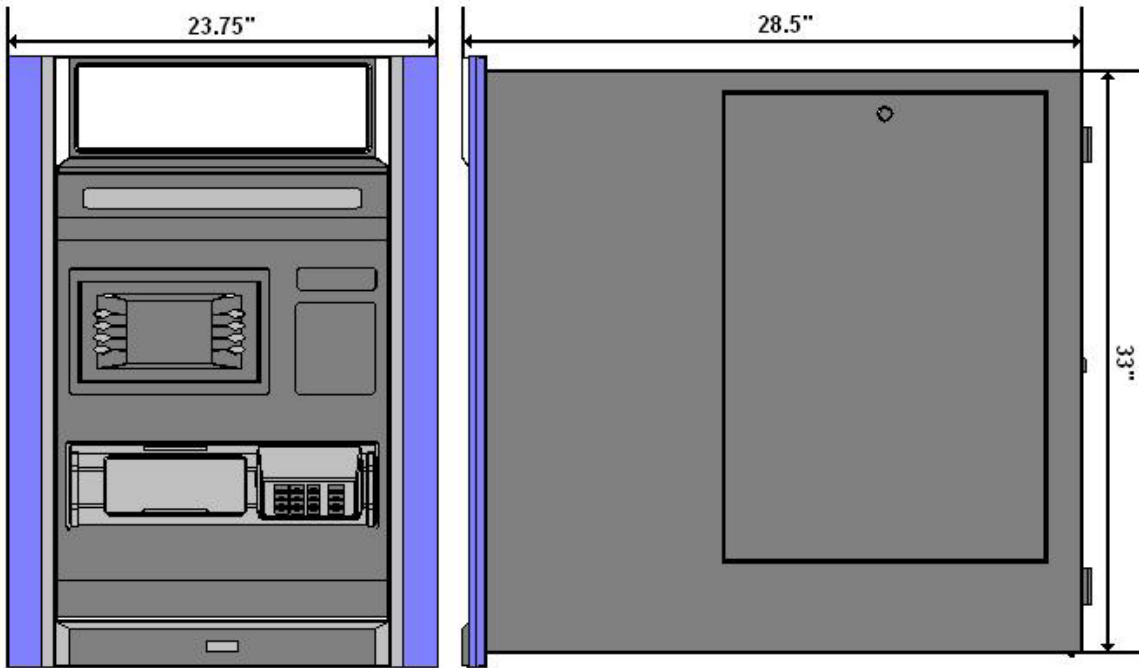

Fig. 3.1 Dimensions

3.2 Component Name and Locations

Component Location (Front)



Fig. 3.2 Component Location (Front)

- | | |
|--------------------------|----------------------|
| 1. Lighted Top Panel | 5. Flicker |
| 2. LCD & Customer Keypad | 6. Card Reader Slot |
| 3. Cash Tray | 7. Earphone Jack |
| 4. Slip Printer Slot | 8. Encrypted PIN Pad |

Component Location (Back)



Fig. 3.3 Component Location (Back)

- | | |
|-----------------------------|----------------------------|
| 1. Slip Printer(SPR) | 4. Supervisor Panel(T-SPL) |
| 2. Cash Dispenser Unit(CDU) | 5. System Door |
| 3. Vault Door | |

3.3 LCD & Customer Keypad



Fig. 3.4 LCD & Customer Keypad

- Screen Size : 5.7" Mono LCD
- Resolution : 320 × 240
- Display Characters : 40 × 15 (Standard Character)

Keypad

- 10 Alphanumeric , ◀ , ▶ , CANCEL, CLEAR, ENTER, BLANK Keypads
- 8 Function Keys

ADA Port

- Voice assisted operation available through the headphone jack on the front bezel

3.4 CDU (Cash Dispensing Unit)

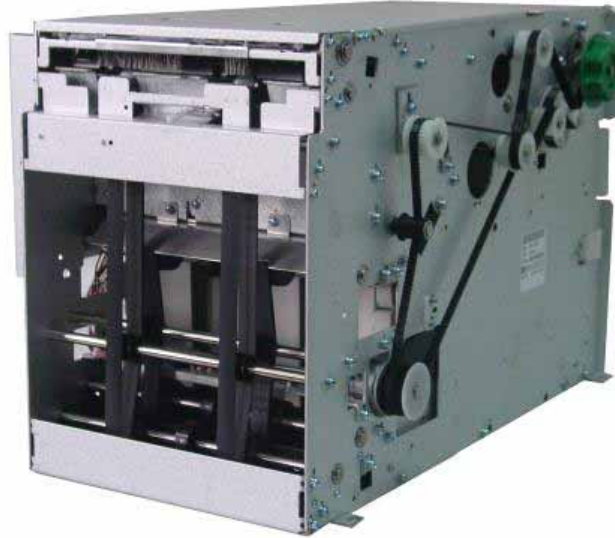

Fig. 3.5 CDU

Cash Dispenser Unit

- Friction feed cash dispensing unit
- Dispensing speed : 7 notes/second
- Capacity of 2,000 new notes
- Reject bin with capacity of 200 notes
- Cash tray sensors
- Slides out for easy service
- Double detection/Skewed note sensors

3.5 SPR (Slip Printer/Receipt Printer)

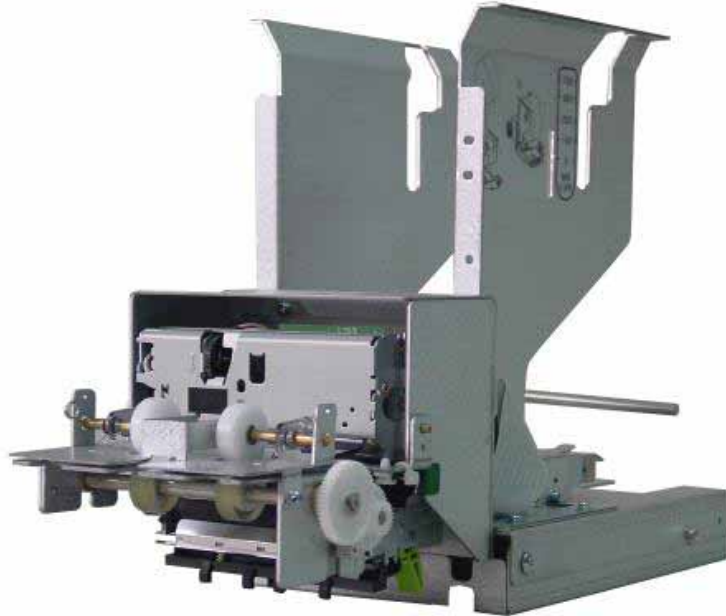

Fig. 3.6 SPR

Receipt Printer

- 3 1/8" thermal printer
- 100 mm/sec print speed
- Automatic paper loading and cutting
- Paper out sensor
- Accommodates a 7" roll & slides out for easy service
- See Appendix C : RECEIPT PAPER SEPECIFICATIONS

3.6 MCU (Magnetic Card Unit)

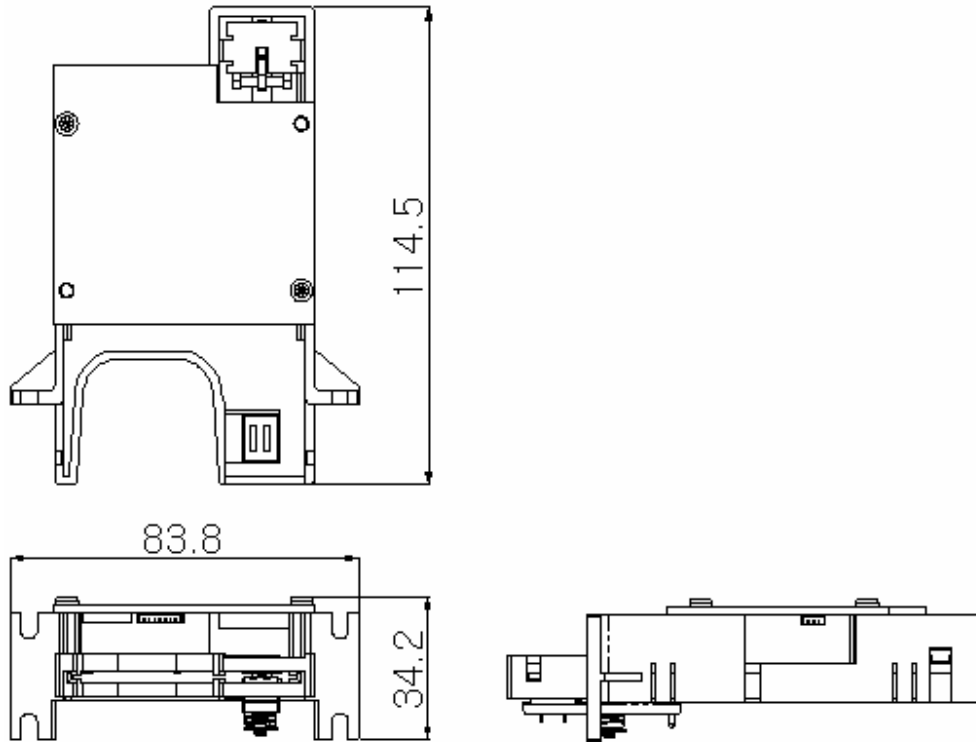

Fig. 3.7 MCU

Magnetic Card Unit

- Dip type Card Reader (ISO Track 1 & 2)
- Card read timing : Ejection
- Readable ejection speed : 6 inches ~ 39.3 inches/second
- MTBF : 1 million passes
- See Appendix D : MAGNETIC CARD SPECIFICATIONS

MTBF : Mean Time Between Failures

3.7 Main Control Board



Fig. 3.8 Main Control Board

- Modem : 56kbps dial-up modem (standard)
- Electronic Journal : Max 2,000 transactions
- Battery back-up for set-up parameters
- Real Time Clock

3.8 Operating Environment

Power Requirements

115 Vac \pm 10% 3.0A 60Hz , 350 Watt

230 Vac \pm 10% 1.5A 50Hz , 350 Watt

Power Connections

The NH 2100T ATM must be connected to a dedicated power circuit. This circuit must consist of **LINE**, **NEUTRAL** and **GROUND** leads connected directly to the power circuit breaker panel. This circuit cannot be shared with any other equipment.

Phone Line Requirements

The NH 2100T ATM must be connected to a dedicated phone line. This line must be a direct dial "tone" or "pulse" line that is equipped with a standard telephone wall jack (RJ-11). This line cannot be shared with any other equipment at the location.

Temperature

- In storage : 32°F - 123°F (0°C ~ 49°C)
- While operating : 40°F - 95°F (5°C ~ 35°C)

Humidity

- In storage : 10% < RH < 90%, Non-Condensed
- While operating : 25% < RH < 85%, Non-Condensed

Chapter 4. Operating Instructions

4. Operating Instructions

4.1 Opening and Closing the Doors

Opening the Doors



- 1) Turn the key in 90 degrees clockwise and then open the door.



- 2) Enter the password.
(Default : 123456)



- 3) Turn the handle clockwise and open the vault door.

Fig.4.1.1 Opening the Doors

Closing the Doors



- 1) Close the Vault Door and turn the handle counterclockwise. The Vault Door will be locked in 5~6 seconds automatically.



- 2) Close the door and turn the key counterclockwise.

Fig.4.1.2 Closing the Security Door

4.2 Replenishing the Cash Cassette



- 1) With one hand holding the cassette handle and the other hand supporting the cash cassette from bottom, pull it up and out carefully.



- 2) Place the cash cassette on a flat level platform and turn the cassette key clockwise to unlock the cassette cover. Then lift the cassette cover.



- 3) After pulling the board back, place bills into the designated tray in a uniform manner. Push the board so that it gently sticks to bills.

Fig.4.2 Replenishing the Cash Cassette

NOTE :

1. Fan the notes so that the notes are not sticking together.
2. Remove all notes with holes or notes that are torn.
3. Unfold the folded notes.
4. Place the notes correctly.

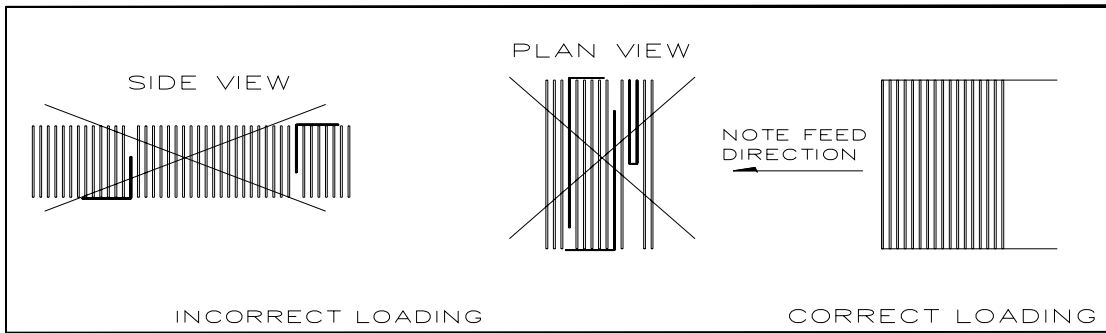

4.3 Emptying the Reject Box



1) Insert the reject box key, turn it clockwise, and pull box lid.



2) Take bills in reject box

Fig. 4.3 Emptying the reject box

4.4 Removing Bills



- 1) Pull the Cash Dispenser Unit forward while pressing the highlighted green button on the bottom of the system.

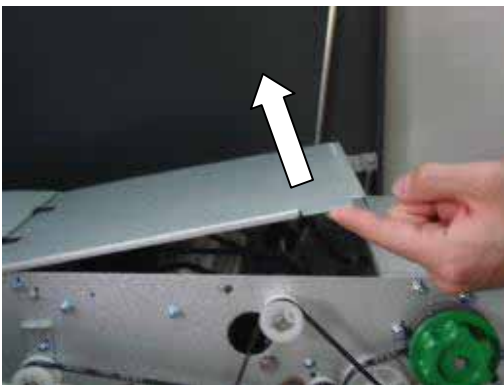

- 2) Open the cover.

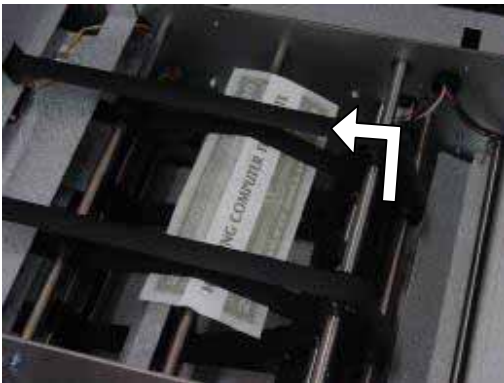

- 3) Check bills in the dispensing part of the system.



Fig. 4.4 Note jam removal

- 4) Take it out by using the side of the belt.

4.5 Loading the Receipt Paper



- 1) Pull the Slip Printer Unit forward while pressing the highlighted green button on the bottom of the system

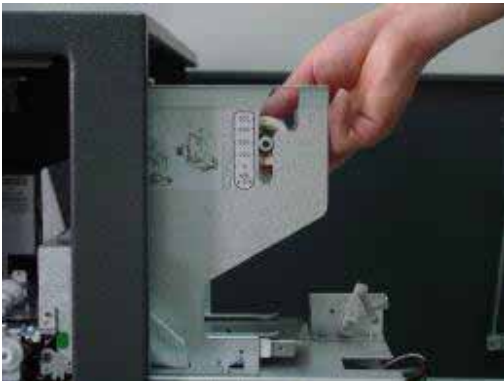

- 2) Put Receipt paper on the guide with the printed surface facing upward.

Note: Maintain the printed surface's direction

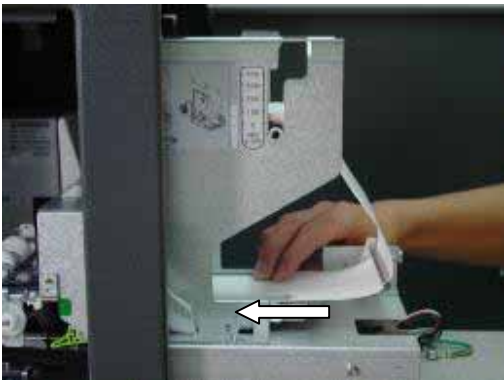

- 3) When you push Receipt paper as shown in the figure, the supplementing feature will be automatically set.

Fig. 4.5 Loading the Receipt Paper

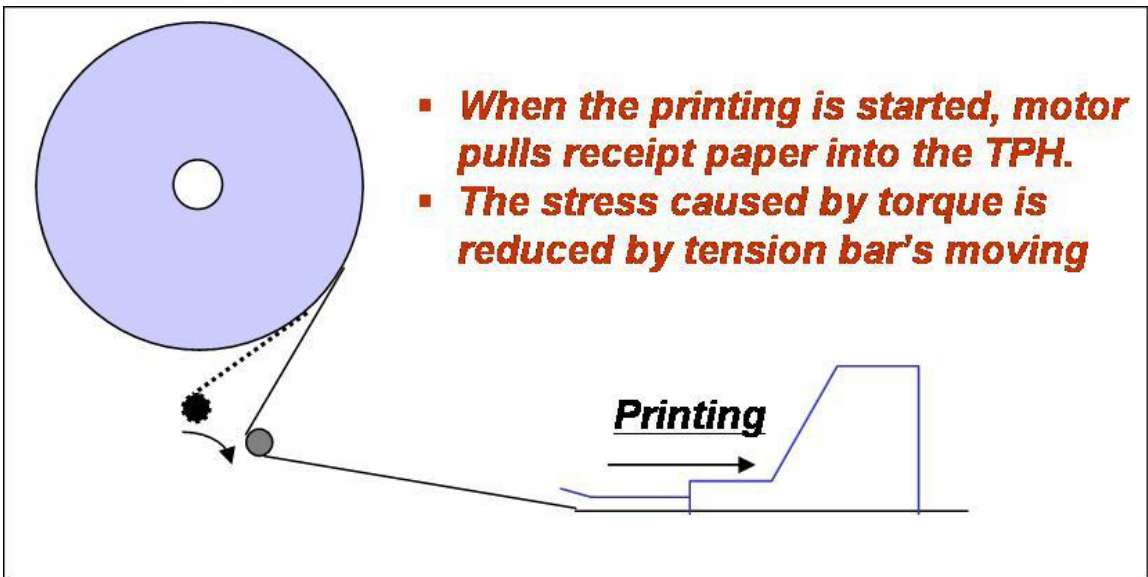
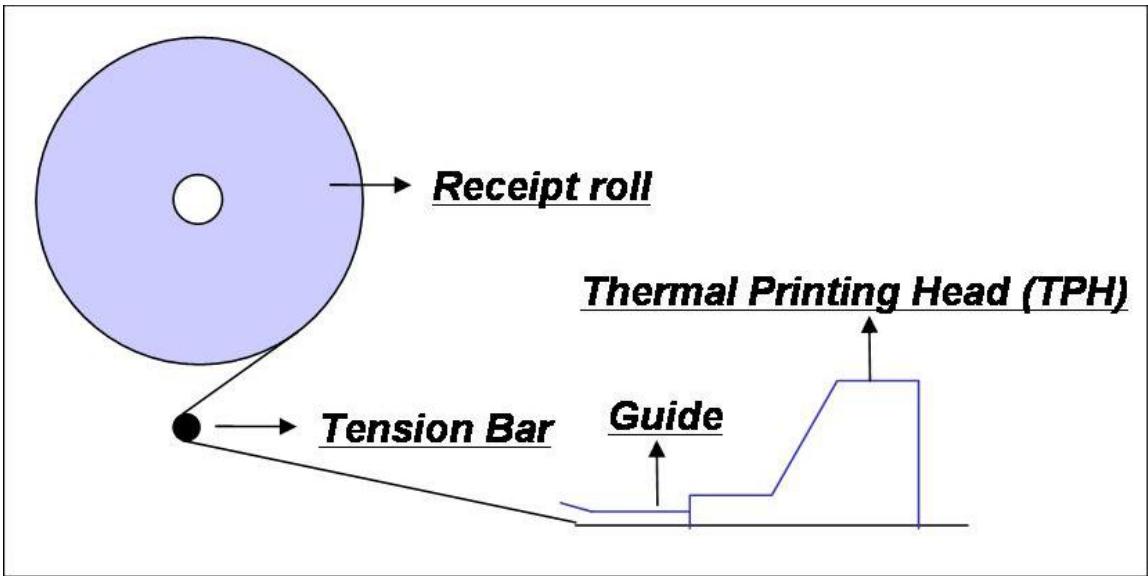

4.6 Receipt(Slip) Paper Jam Removal

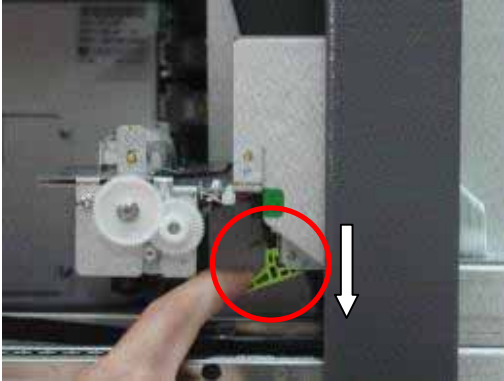

- 1) Take down the guide and lift the head open lever to the down direction.



- 2) Remove the receipt paper jammed inside and then set the receipt paper again.



- 3) Place the printer head lever to up position.

Fig. 4.6 Receipt Paper Jam Removal

Chapter 5. Operator Functions

5. Operator Functions

5.1 Basic System Operation

Entering to Operator Function Menu



1) Change to supervisor mode by pressing highlighted switch.



2) Enter the Operator Password and press. If the wrong password is entered, the screen will be back to "ENTER PASSWORD" screen. The factory default Operator Password is "222222".

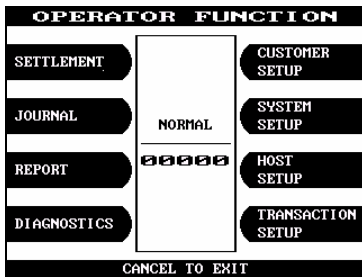

3) If the correct password is entered, the OPERATOR FUNCTION menu will be displayed.

Fig. 5.1 Entering to Operator Function Menu

How to Use Keypad

This section will explain the basic operation of the Keypad.

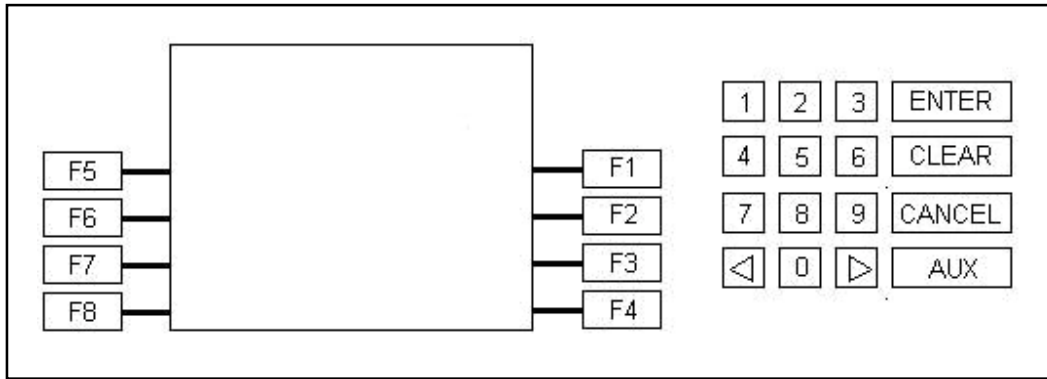

Fig. 5.2.1 Keypad

Shift Status			0	1	2	3	4	5	6	7	8	9
F5	Alpha	Upper	+	Space	A	D	G	J	M	P	T	W
			-	Q	B	E	H	K	N	R	U	X
	=	Z	C	F	I	L	O	S	V	Y		
	Lower	+	Space	a	D	G	j	m	p	t	w	
-		q	b	e	H	k	n	r	u	x		
Numeric	Don't care	0	1	2	3	4	5	6	7	8	9	
		([{	<	,	!	'	%	:	?	
Table	Don't care)]	}	>	.	\$	"	*	;	/	
		The character on the current cursor position on the screen will be selected.										

Fig. 5.2.2 Keypad Character Table

How to Enter the Character

- a. The Keypad Character Table of Fig. 5.2.2 will appear on the bottom of the screen in all keypad input screens.
- b. F5 key gives the option for Alpha or Numeric, Table mode. Default is Alpha.
- c. F6 key gives the option for Upper or Lowercase characters. It is valid only in the Alpha mode. Default is Uppercase.
- d. The input of characters is limited to the space provided.
- e. Keys are in toggle fashion such as, when key "1" is pressed once it is "SPACE", pressed twice it is "Q", pressed third time it is "Z" when in the Alpha mode. When the desired character is selected, press ENTER.
- f. ◀ , ▶ keys move the cursor position in the Alpha or Numeric mode. In the Table mode ◀ , ▶ keys are used to select the character.
- g. F1 key is used to clear the whole screen and returns the cursor to its initial position.
- h. F2 key is used to clear the current line.
- i. F3 key is used to ignore the changes and to exit.
- j. F7 key is used to save the current changes and to exit.

5.2 Settlement

The Settlement Function of the Operator Function includes the following :

**DAY TOTAL / TRIAL DAY TOTAL
CASSETTE TOTAL / TRIAL CASSETTE TOTAL
ADD CASSETTE #1**

5.2.1 Day Total / Trial Day Total

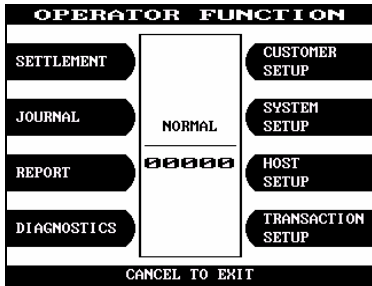

1) Press 'SETTLEMENT' button in the OPERATOR FUNCTION menu.



2) Press 'DAY TOTAL' / 'TRIAL DAY TOTAL' in the SETTLEMENT menu.

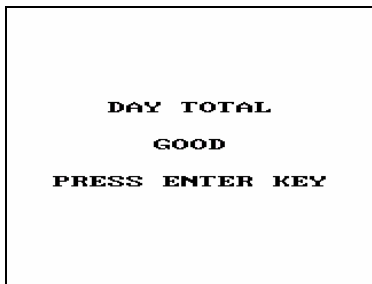

3) After the information is downloaded from the processor, the Day Total / Trial Day Total information will be printed on receipt paper.

Fig. 5.3 DAY TOTAL / TRIAL DAY TOTAL

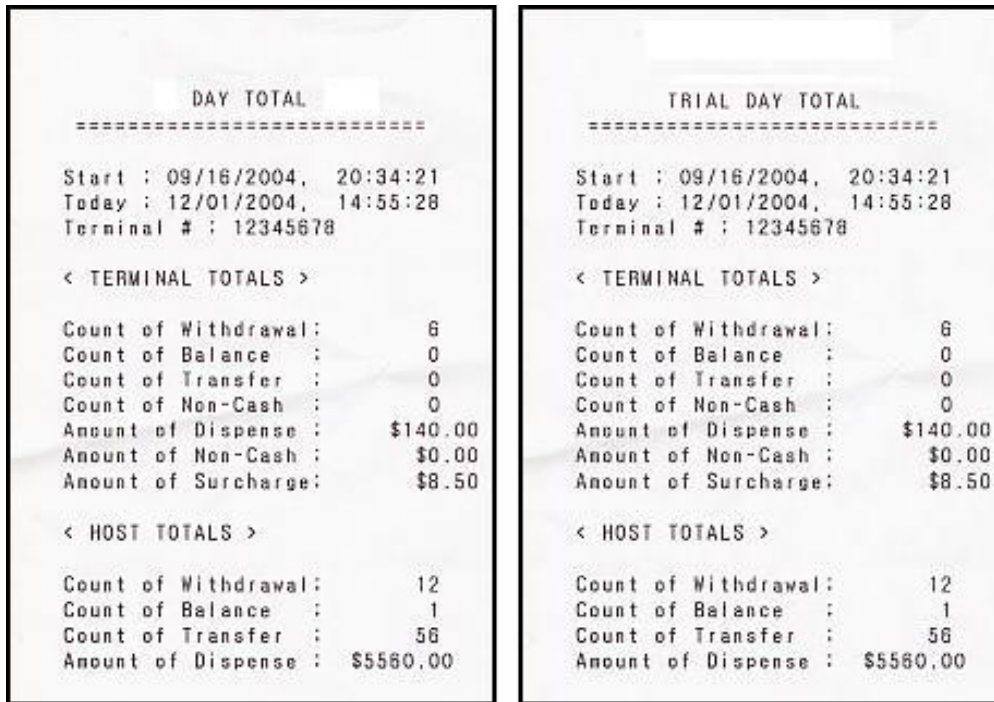

Fig. 5.4 A sample print out of DAY TOTAL and TRIAL DAY TOTAL

Function Description

The DAY TOTAL includes all information of the ATM terminal totals and the host totals. If the host can not be connected, an "ERROR" message will be displayed and only the ATM terminal totals will be printed without verification with the host. All information will be deleted after the use of this function.

The TRIAL DAY TOTAL function is used anytime to confirm the totals since the last DAY TOTAL. It does the same function as the DAY TOTAL, except the day total information is not cleared.

5.2.2 Cassette Total / Trial Cassette Total

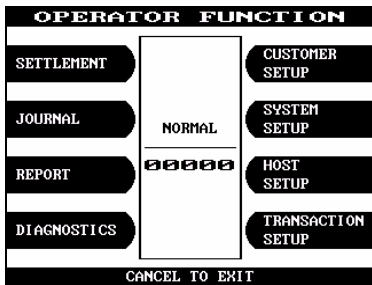

1) Press 'SETTLEMENT' button in the OPERATOR FUNCTION menu.

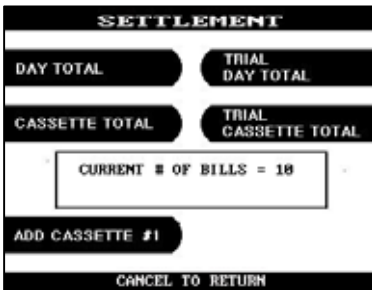

2) Press '(TRIAL) CASSETTE TOTAL' button in the SETTLEMENT menu.

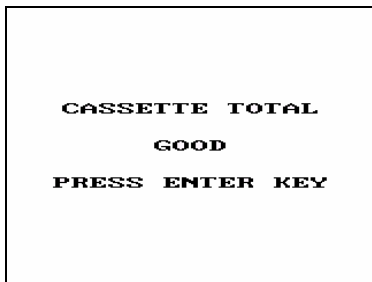

3) The (Trial) Cassette Total information will be printed on receipt paper.

Fig. 5.5 CASSETTE TOTAL / TRIAL CASSETTE TOTAL

CASSETTE TOTAL =====		TRIAL CASSETTE TOTAL =====	
Start:	09 / 23 / 2004 , 12:35:49	Start:	09 / 23 / 2004 , 12:35:49
Today:	09 / 23 / 2004 , 16:13:31	Today:	09 / 23 / 2004 , 16:13:31
Terminal #	: 11111111	Terminal #	: 11111111
Loaded	: 200	Loaded	: 200
Dispensed	: 190	Dispensed	: 190
Rejected	: 0 (1 or more)	Rejected	: 0 (1 or more)
Test	: 0	Test	: 0
<hr/>		<hr/>	
Remaining	: 10	Remaining	: 10
Value of each note	= \$10	Value of each note	= \$10

Fig. 5.6 A sample print out of CASSETTE TOTAL and TRIAL CASSETTE TOTAL

Function Description

The CASSETTE TOTAL includes the total loaded number of bills in the cassette, the normal dispensed amount, the number of rejected notes, the test dispensed amount and the number of remaining notes, etc. since the last CASSETTE TOTAL was operated. This will be printed from the Receipt Printer. All information will be deleted after the use of this function.

The TRIAL CASSETTE TOTAL function is used to check the amount dispensed from the cassette since the last CASSETTE TOTAL was operated. It does the same function as the CASSETTE TOTAL, except the cassette total information is not cleared.

5.2.3 Add Cassette #1

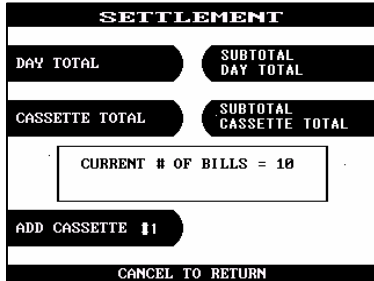

1) Press 'ADD CASSETTE #1' button in the SETTLEMENT menu.



2) Enter the number of bills loaded in the cassette. And the number of bills will be accumulated.

NOTE : Enter the number of bills, NOT the amount of cash.

Fig. 5.7 ADD CASSETTE

Function Description

The operator must set the additional number of bills being loaded into the cash cassette at all times. After the use of CASSETTE TOTAL, the current number of bills will be reset to "0".

5.3 Journal

The Journal Function of the Operator Function includes the following:

PRINT JOURNAL
LAST X PRINT
VIEW JOURNAL
CLEAR JOURNAL
CLEAR TRANSACTION SEQUENCE NUMBER

5.3.1 Print Journal

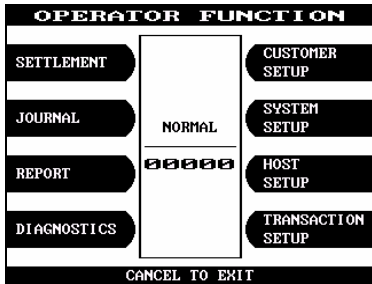

1) Press 'JOURNAL' button in the OPERATOR FUNCTION menu.



2) Select 'PRINT JOURNAL' in the JOURNAL menu.

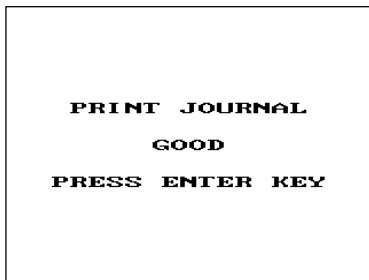

3) Wait while the Journal data is being printed. If the GOOD message appears, press "ENTER".

Fig. 5.8 PRINT JOURNAL

```

                JOURNAL PRINT
=====
TODAY: 12/02/2004. 01:00:55

<00007> 12/01/2004 10:17:22 PM
  *** NORMAL TRANSACTION ***

      *** WITHDRAWAL ***
TERMINAL NO : 70330999
SEQUENCE NO : 0001
ACCOUNT FROM : CHECKING
CARD DATA  : .....0031
HOST DATE   : 12/01/2004
HOST TIME   : 17:49:12
REQUESTED   :      $20.00
DISPENSED   :      $20.00
BALANCE     :    $1234.58
PROC COUNT  : 9

```

Fig. 5.9 A sample print out of PRINT JOURNAL

Function Description

The PRINT JO URNAL function is used to automatically print out any journal entries collected since the last time this command was operated.

5.3.2 Last X Print

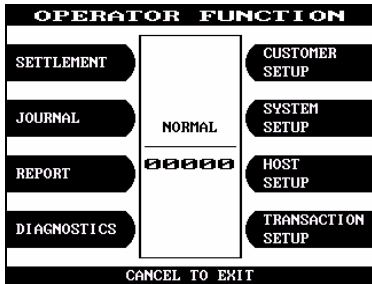

1) Press 'JOURNAL' button in the OPERATOR FUNCTION menu.



2) Press 'LAST X PRINT' button in the JOURNAL menu.

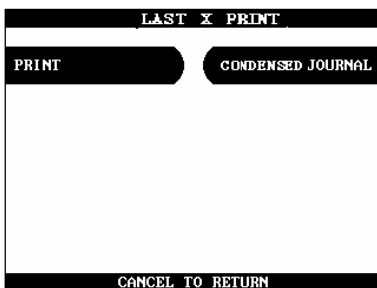

3) Press 'PRINT' / 'CONDENSED JOURNAL' button in the LAST X PRINT menu.

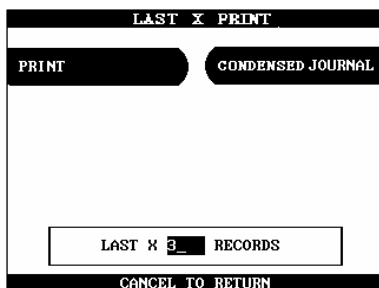

4) Enter the number of records to be printed. Wait while the Journal data is being printed.

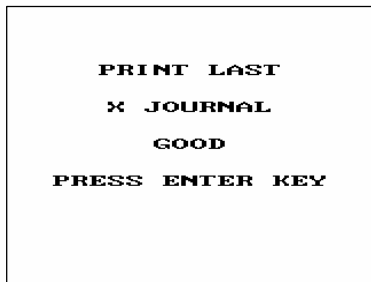

- 5) If the GOOD message appears, press "ENTER".

Fig. 5.10 LAST X PRINT(PRINT/CONDENSED PRINT)

Function Description

The LAST X PRINT(PRINT) function is used to reprint records for which the paper trail has been lost or destroyed. Reprint certain range of journal data specified by X record after they have been printed or cleared.

The LAST X PRINT(CONDENSED JOURNAL) function is used to reprint condensed records for which the paper trail has been lost or destroyed. Reprint as condensed certain range of journal data specified by X record after they have been printed or cleared.

5.3.3 View Journal

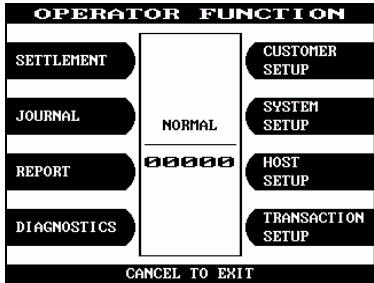

1) Press 'JOURNAL' button in the OPERATOR FUNCTION menu.



2) Press 'VIEW JOURNAL' button in the JOURNAL menu.



3) You may see the Journal Data which will be displayed on the screen.

Fig. 5.11 VIEW JOURNAL

Function Description

The VIEW JOURNAL function is used to display the journal data in the LCD screen.

5.3.4 Clear Journal

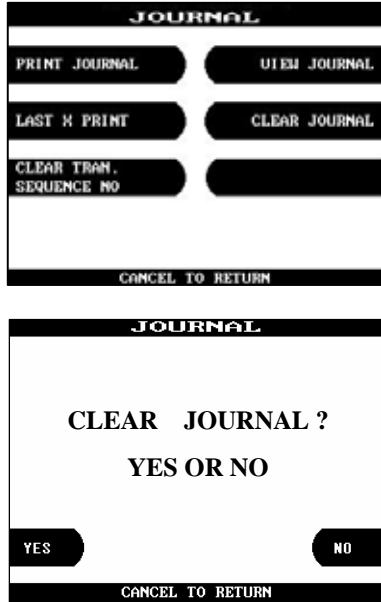

- 1) Press 'CLEAR JOURNAL' button in the JOURNAL menu. The pointer of Journal data to print will be reset.

Fig. 5.12 CLEAR JOURNAL

Function Description

The CLEAR JOURNAL function is used to mark all records not printed in the journal. Journal records are not erased. They are marked as if they had been printed.

5.3.5 Clear TRAN. Sequence No.

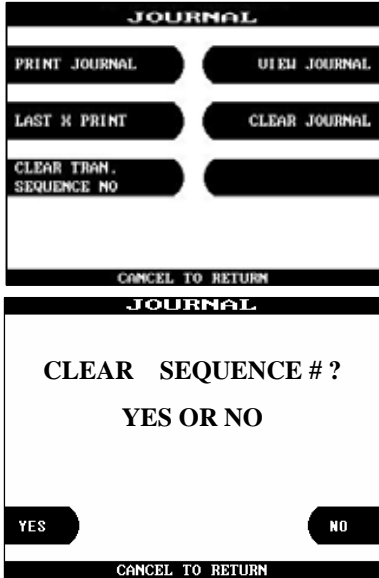

- 1) Press 'CLEAR TRAN. SEQUENCE NO.' button in the JOURNAL menu. Transaction Sequence Number will be reset to '1' if "YES" is pressed. It will not be reset if "NO" is pressed.

Fig. 5.13 CLEAR TRAN. SEQUENCE NO.

Function Description

The CLEAR TRAN. SEQUENCE NO. function is used to reset the transaction serial number as "1".

5.4 Report

The Report function of the Operator Function includes the following :

ERROR CODE
MEMORY DUMP
S/W VERSION
PRINT ALL SETUP
ERROR SUMMARY
STATISTICS
REJECT ANALYSIS

5.4.1 Error code

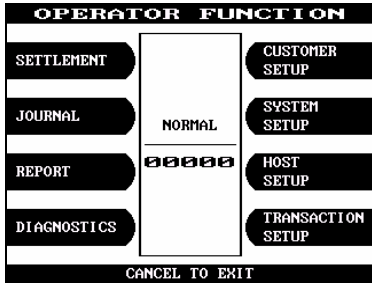

1) Press 'REPORT' button in the OPERATOR FUNCTION menu.

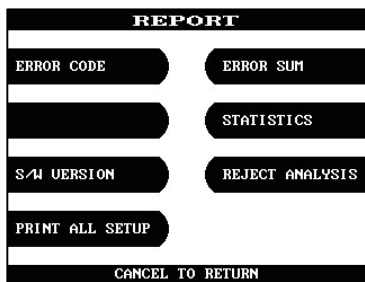

2) Press 'ERROR CODE' button in the REPORT menu.

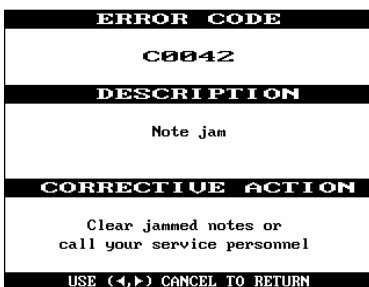

3) The Error code, description and corrective action will be displayed.

Fig. 5.14 ERROR CODE

Function Description

The ERROR CODE includes all error codes, descriptions and corrective actions. If an error occurs, the current error code will be displayed. To search the error code, use ◀ , ▶ key.

5.4.2 S/W Version



1) Press 'S/W VERSION' button in the REPORT menu.



2) Software Version will be displayed. To print the Software Version information, press "ENTER".

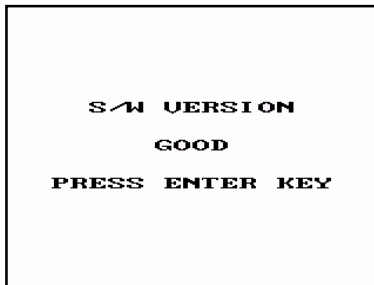

3) Software version will be printed from the receipt printer.

Fig. 5.16 S/W VERSION

```

                S/W VERSION
=====
TODAY:  12/01/2004.  15:00:46

  HYOSUNG.  MB-TTW.  MONO
-----
BIOS      : VA0.00.01
APPLICATION : VA0.00.05
RMS       : V05.00.00
-----
SPR ROM   : V00.03.02
COU ROM(U1G)04 : V07.00.03
EPP ROM   :
  < SEGMENT CHECK SUM >
-----
BIOS : F6C9      SYSTEM : 003B
APPL : FDB1      TABLE  : D689

```

Fig. 5.17 A sample print out of S/W Version Print

Function Description

The S/W VERSION function is used to display each software version of system.

5.4.3 Print All Setup



1) Press 'PRINT ALL SETUP' button in the REPORT menu.



2) All setup parameters will be printed from the Receipt Printer. If the GOOD message appears, press "ENTER".

Fig. 5.18 PRINT ALL SETUP

Function Description

The PRINT ALL SETUP function is used to print all parameters of the system.

5.4.4 Error Sum



1) Press 'ERROR SUM' button in the REPORT menu.

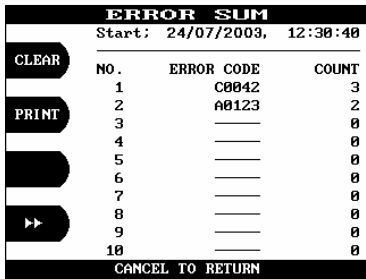

2) The error summary data will be displayed. Press "PRINT" key to print the Error Sum Data.

Fig. 5.19 ERROR SUMMARY

Function Description

The ERROR SUM function is used to display the error code and number of times the error occurred since the last ERROR SUM CLEAR. Therefore an operator can know which error occurs frequently and with this function it is useful for preventive maintenance. To clear all data, press "CLEAR".

5.4.5 Statistics



1) Press 'STATISTICS' button in the Report Menu.

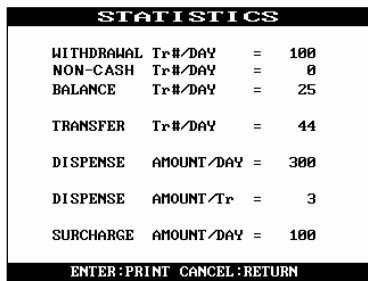

2) Statistics data will be displayed. Press "ENTER" key to print data.

Fig. 5.20 STATISTICS

Function Description

The STATISTICS displays all transaction statistics data. To clear the data, press "CLEAR".

5.4.6 Reject Analysis



1) Press 'REJECT ANALYSIS' button in the REPORT menu.

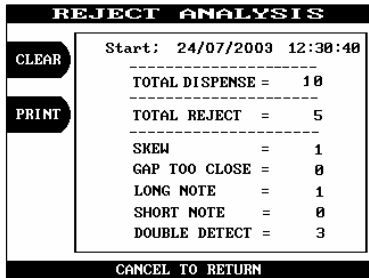

2) Reject Analysis data will be displayed. Press "PRINT" key to print data.

Fig. 5.21 REJECT ANALYSIS

Function Description

The REJECT ANALYSIS function includes the analysis for the reason of the note reject and it is useful for the preventive maintenance.

5.5 Diagnostics

The Diagnostic function of Operator Function includes the following:

**INITIALIZE
RECEIPT PRINTER
CASH DISPENSER
MODEM
CARD SCAN
KEY MATRIX
SENSOR
AGING**

Changing the TEST COUNT

The TEST COUNT means the number of test.

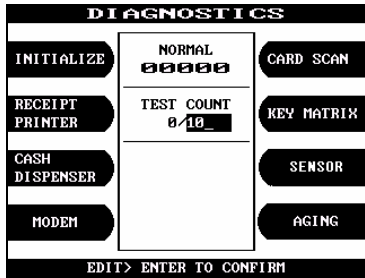

- 1) If you want to change the test count, press "CLEAR" then input the test count and press "ENTER".

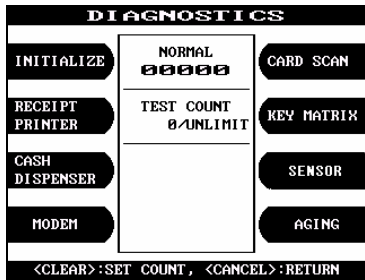

- 2) If you input '0 (zero)', the test count will be changed to unlimited.

Fig. 5.22 CHANGING THE TEST COUNT

Test Tip

If an error occurs while executing, the system will stop and display an error code. Confirm the detailed error description in ERROR CODE TABLE in "Chapter 6 Appendix".

5.5.1 Initialize

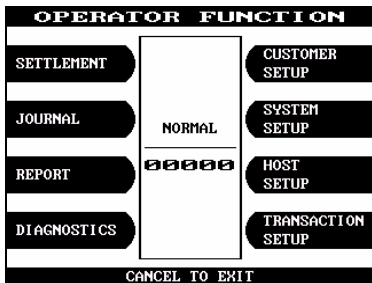

1) Press 'DIAGNOSTICS' button in the OPERATOR FUNCTION.

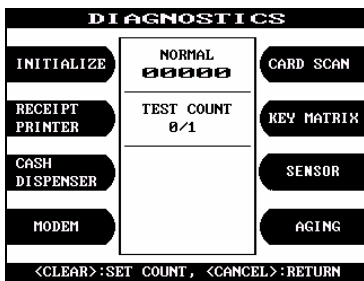

2) Press 'INITIALIZE' button in the DIAGNOSTICS menu. All units will be initialized.

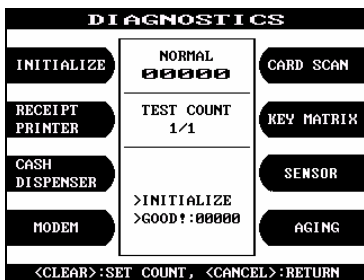

3) When the ATM is in the normal state, the GOOD message will be displayed. If not, error code will be displayed on LCD screen.

Fig. 5.23 INITIALIZE

Function Description

The INITIALIZE has the function of resetting each unit of the NH 2100T.

5.5.2 Receipt Printer

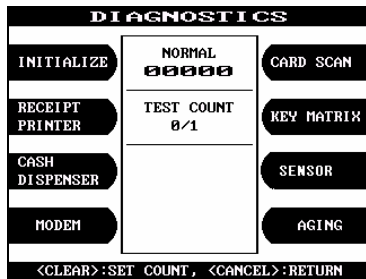

- 1) Press 'RECEIPT PRINTER' button in the DIAGNOSTICS menu. Test String will be printed from the receipt printer.

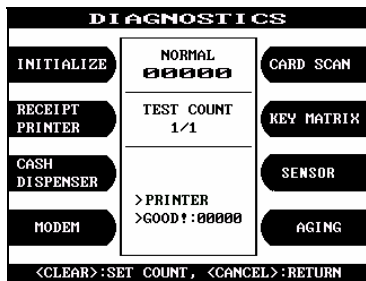

- 2) When the ATM is in the normal state, the GOOD message will be displayed. If not, error code will be displayed on LCD screen.

Fig. 5.24 RECEIPT PRINTER

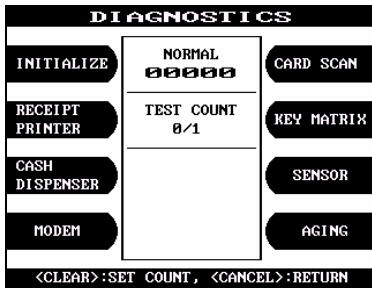

Fig. 5.25 A Sample of the print out from RECEIPT PRINTER TEST

Function Description

The RECEIPT PRINTER has the function of printing a sample receipt and cutting out one receipt.

5.5.3 Cash Dispenser



- 1) Press the 'CASH DISPENSER' button in the DIAGNOSTICS menu. The CASH DISPENSER test will be performed.

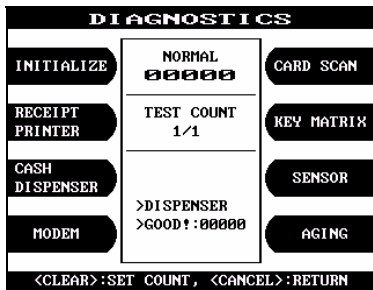

- 2) When the ATM is normal state, the GOOD message will be displayed.

Fig. 5.26 CASH DISPENSING UNIT

Function Description

The CASH DISPENSER has the function of testing the dispense mechanisms. This function will dispense one note from the cassette and dump into the reject bin.

5.5.4 Modem

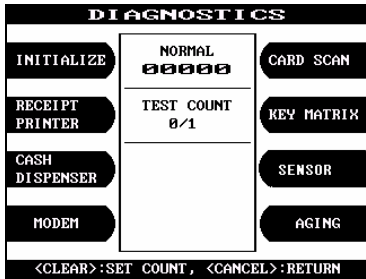

1) Press 'MODEM' button in the DIAGNOSTICS menu.

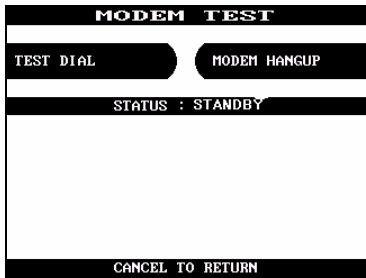

2) The MODEM TEST will be displayed.

Fig. 5.27 MODEM

Function Description

The MODEM has the function of testing the modem for any errors. When the phone number input is displayed after pressing the TEST DIAL key, input the desired phone number. The TEST DIAL function is used to check the function of the modem dial. The MODEM HANGUP function is used to hang-up the dialing after using TEST DIAL.

5.5.5 Card Scan

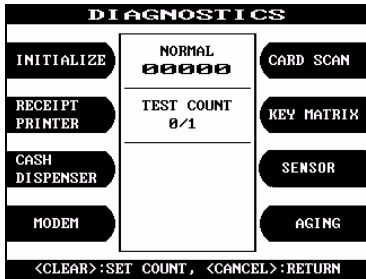

- 1) Press 'CARD SCAN' button in the DIAGNOSTICS menu. And if the display is ready, please insert and remove your card quickly.



- 2) The card data will be displayed.

Fig. 5.28 CARD SCAN

Function Description

The CARD SCAN has the function of testing the magnetic stripe reader and the card itself.

5.5.6 Key Matrix

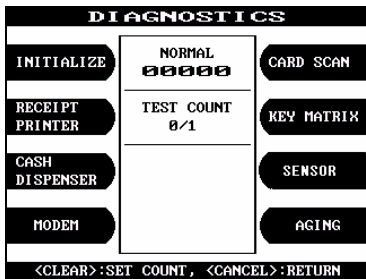

1) Press 'KEY MATRIX' button in the DIAGNOSTICS menu.

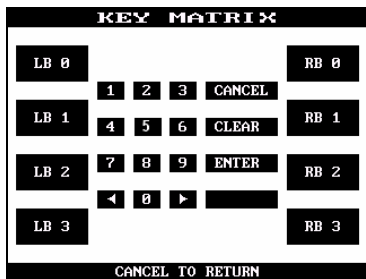

2) Select the desired key to be tested and the key being pressed will blink on the display.

Fig. 5.29 KEY MATRIX

Function Description

The KEY MATRIX has the function of testing the key pad.

5.5.7 Sensor

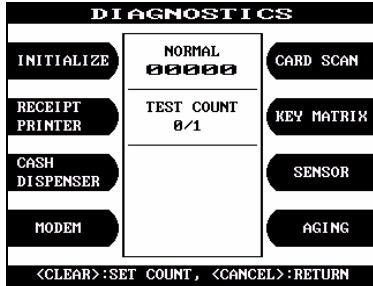

1) Press 'SENSOR' button in the DIAGNOSTICS menu.

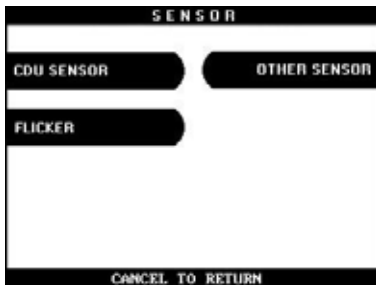

2) Press a button you want to check in the SENSOR menu.

Fig. 5.30 SENSOR Main Screen

CDU SENSOR



Fig. 5.31 CDU SENSOR Screen

- 1) All sensor data of cash dispenser will be displayed. Each CDU sensor status will be changed by turning the sensors on and off.

OTHER SENSOR



Fig. 5.32 OTHER SENSOR Screen

- 1) All sensor data will be displayed. Each sensor status will be changed by turning the sensors on and off.

FLICKER



Fig. 5.33 FLICKER Screen

- 1) ATM has 3 kinds of flicker(MCU,SPR and CDU). Each flicker will be blinking by pressing buttons

Function Description

The SENSOR has the function of testing if all the sensors are in proper working condition. The sensors are tested by turning the sensors on and off.

5.5.8 Aging

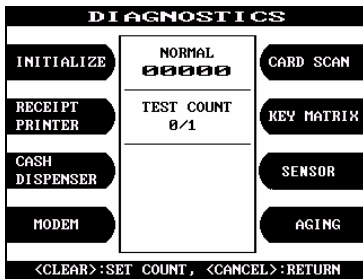

1) Select 'AGING' in the 'DIAGNOSTICS' menu.

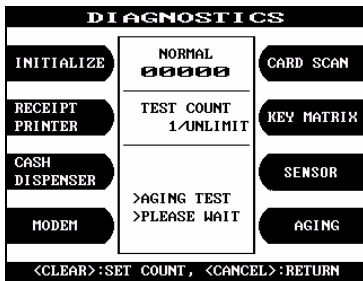

2) All units will be tested upto count you set. When you press "CANCEL" key, the testing will be stopped immediately.

Fig. 5.34 AGING

Function Description

The AGING function is only used at the factory.

5.6 CUSTOMER SETUP

The Customer Setup function of the OPERATOR MENU includes the following :

CHANGE MESSAGE
BIN LIST
SURCHARGE MODE
ADVERTISEMENT
OPTIONAL FUNCTION
OPTIONAL SETTING

5.6.1 Change message

WELCOME MESSAGE

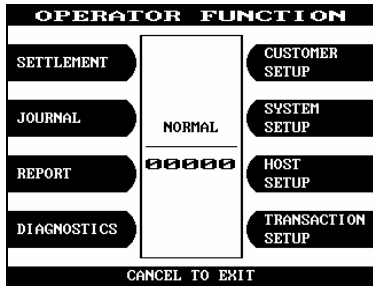

1) Press 'CUSTOMER SETUP' button in the OPERATOR FUNCTION menu.



2) Select the 'CHANGE MESSAGE' in the CUSTOMER SETUP menu.



3) Select the 'WELCOME MESSAGE' in the CHANGE MESSAGE menu.



4) You can edit the welcome message. Please refer to “How to use keypad”(Chapter 5.1 Basic System Operation).

Fig. 5.35 WELCOME MESSAGE

Function Description

The WELCOME MESSAGE function is used to edit the welcome text in “INSERT AND REMOVE YOUR CARD QUICKLY” screen. The factory default message is “WELCOME!!!”.

RECEIPT HEADER



1) Select the 'CHANGE MESSAGE' in the CUSTOMER SETUP menu.



2) Select the 'RECEIPT HEADER' in the CHANGE MESSAGE menu.



3) You can edit the RECEIPT HEADER. Please refer to "How to use keypad"(Chapter 5.1 Basic System Operation).

Fig. 5.36 RECEIPT HEADER

Function Description

The RECEIPT HEADER function is used to edit the message at the header of receipt. The factory default message is none.

5.6.2 Bin List



1) Select the 'BIN LIST' in the CUSTOMER SETUP menu.



2) Select BIN LIST you want to register.

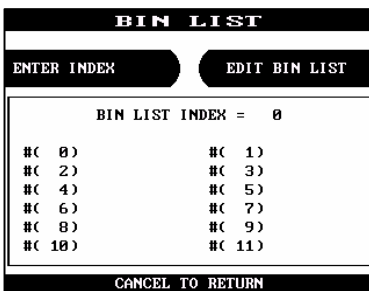

3) The BIN LIST menu will be displayed.

Fig. 5.37 BIN LIST

Function Description

The BIN LIST function is used to register bank lists and give bin codes not to surcharge the additional fee. But it is necessary to confirm the connected host because according to the host it can be used or not. After designating the INDEX, input a bin code with using "EDIT BIN LIST".

5.6.3 Surcharge mode



1) Select the 'SURCHARGE MODE' button in the CUSTOMER SETUP menu.

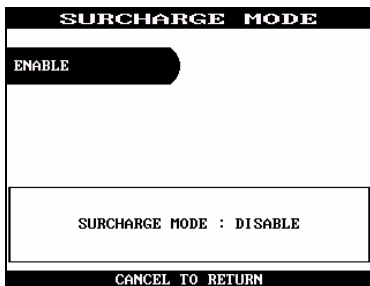

2) The SURCHARGE MODE menu will be displayed.

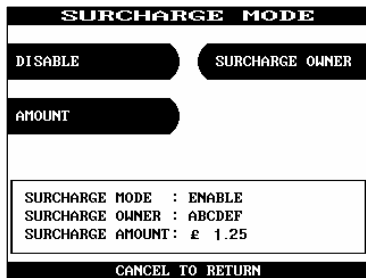

3) If you press the ENABLE key, it will be enabled as displayed.

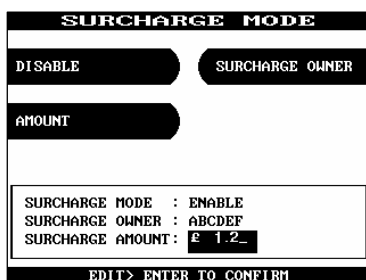

4) If you press the AMOUNT key, you can enter the desired surcharge amount.

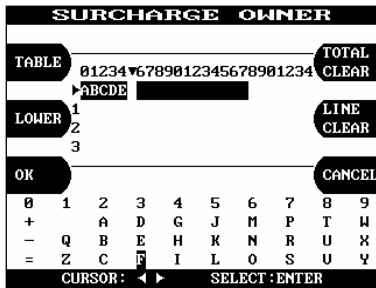

Fig. 5.38 Surcharge Mode

- 5) If you press the SURCHARGE OWNER key, you can enter the owner's name with keypad. Please refer to "How to use keypad"(Chapter 5.1 Basic System Operation).

Function Description

The SURCHARGE MODE includes the function to enable or disable the surcharge warning screen, setting the surcharge amount and surcharge owner. When the surcharge mode is disabled, the surcharge warning message will not be displayed and when the surcharge mode is enabled, the surcharge amount and owner name will be displayed in the surcharge warning screen. The factory default is disabled mode, surcharge amount is \$0.00 and the surcharge owner is none.

5.6.4 Advertisement



1) Select the 'ADVERTISEMENT' button in the CUSTOMER SETUP menu.

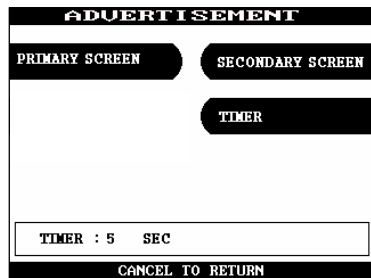

2) The ADVERTISEMENT menu will be displayed.

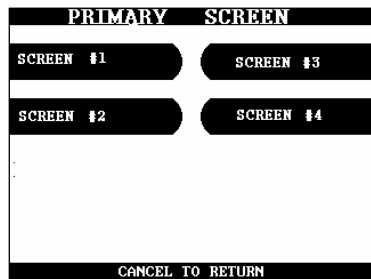

3) If you press the PRIMARY SCREEN key, the PRIMARY SCREEN will be displayed. And select the 'SCREEN #1' in the PRIMARY SCREEN MENU.

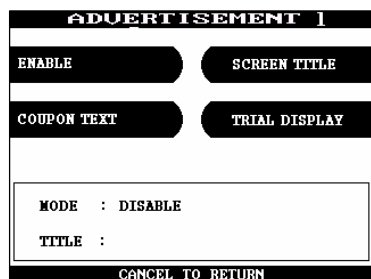

4) If you press the ENABLE/DISABLE key, it will be changed to be enabled or disabled.

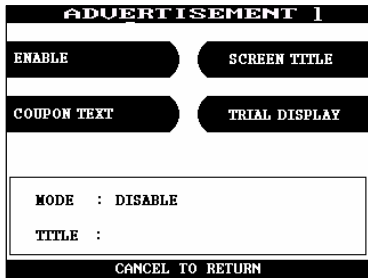

5) Select the 'SCREEN TITLE key' in the PRIMARY SCREEN MENU.

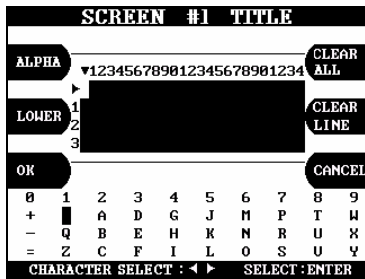

6) If you press the SCREEN TITLE key, you can enter the desired advertisement message. Please refer to “How to use keypad”(Chapter 5.1 Basic System Operation).

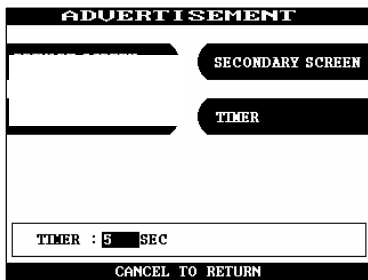

7) If you press the TIMER key, you can input the desired refreshing timer of advertisement text.

Fig. 5.39 Advertisement

Function Description

The ADVERTISEMENT function is used to set the advertisement message displayed during idle time, such as “INSERT AND REMOVE YOUR CARD QUICKLY” and “PLEASE WAIT CONNECTING”. The factory default is disabled mode, 3 seconds and no message. But if there is no message, “HAVE A NICE DAY” will be displayed in the bottom of screen.

5.6.5 Optional Function



- 1) Select the 'OPTIONAL FUNCTION' button in the CUSTOMER SETUP menu.

PRE-DIALING



- 1) Select the 'PRE DIALING' in the OPTIONAL FUNCTION menu.



- 2) If you press the PRE DIALING key, you can change the desired pre-dialing mode.

SELECT RECEIPT



- 1) If you select the 'SELECT RECEIPT' in the OPTIONAL FUNCTION MENU, it will be changed to be enabled or disabled.

Fig. 5.40 Optional Function

Function Description

The 'OPTIONAL FUNCTION' function is used to set PRE-DIALING and set RECEIPT.

5.6.6 Optional Setting



1) Select the 'OPTIONAL SETTING' button in the 'CUSTOMER SETUP' menu.

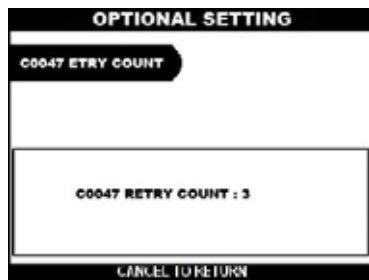

2) ATM will not go to out of service mode until the number of error is exceeded the C0047 RETRY COUNT number. Default number is 3.

5.7 System setup

The SYSTEM SETUP function of the OPERATOR FUNCTION includes the following:

- SET CLOCK
- ISO #1, #2, #3 EN/DISABLE
- LANGUAGE EN/DISABLE
- CHANGE PASSWORD
- MODEM
 - MODEM SETUP
 - DIAL MODE
 - MODEM SPEED
 - SPEAKER OUT
 - INITIAL STRING
 - MODEM TEST
- RMS RING COUNT
- SPEAKER VOLUME
- DEVICE SETUP

5.7.1 Set clock

Accessing the SET CLOCK

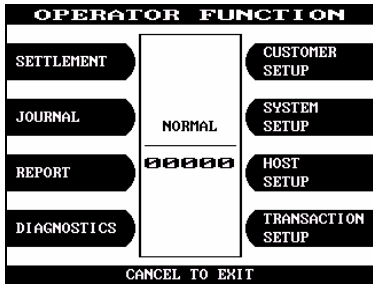

1) Select the 'SYSTEM SETUP' in the OPERATOR FUNCTION menu.

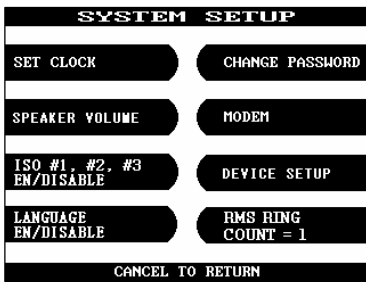

2) Select the 'SET CLOCK' in the SYSTEM SETUP menu.



3) The SET CLOCK menu will be displayed.

Fig. 5.41 SET CLOCK

Function Description

The SET CLOCK function is used to set the date and clock. When the "SECOND" key is pressed, the second will be reset to "0".

5.7.2 ISO #1, #2, #3 En/Disable

Accessing the ISO #1, #2, #3 EN/DISABLE

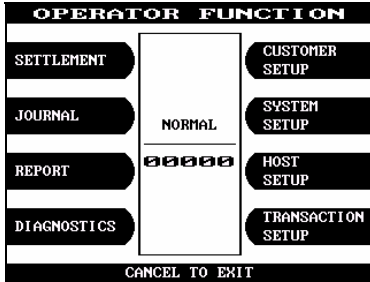

1) Select the 'SYSTEM SETUP' in the OPERATOR FUNCTION menu.

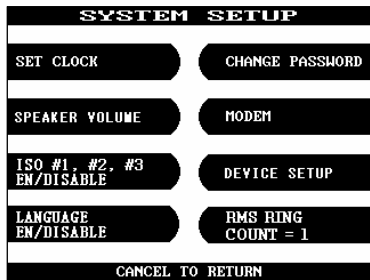

2) Select the 'ISO #1, #2, #3 EN/DISABLE' in the SYSTEM SETUP menu.

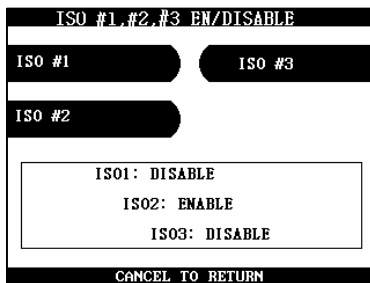

3) If you press the ISO #1, #2, #3 key, it will be changed to be enabled or disabled.

Fig.5. 42 ISO #1, #2, #3 EN/DISABLE

Function Description

The ISO #1, #2, #3 EN/DISABLE includes the function to enable or disable the ISO warning screen. Each key will be changed to be enabled or disabled.

5.7.3 Language en/disable

Accessing the LANGUAGE EN/DISABLE

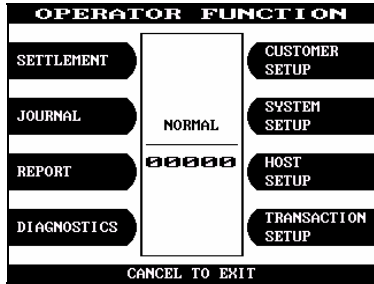

1) Select the 'SYSTEM SETUP' in the OPERATOR FUNCTION menu.



2) Select the 'LANGUAGE EN/DISABLE' in the SYSTEM SETUP menu.



3) If you press the ENGLISH or SPANISH or KOREAN or JAPANSE key, it will be changed to be enabled or disabled.

Fig.5. 43 LANGUAGE EN/DISABLE

Function Description

The LANGUAGE EN/DISABLE key includes the function to enable or disable the LANGUAGE warning screen. Each key will be changed to be enabled or disabled.

5.7.4 Change password

Accessing the CHANGE PASSWORD

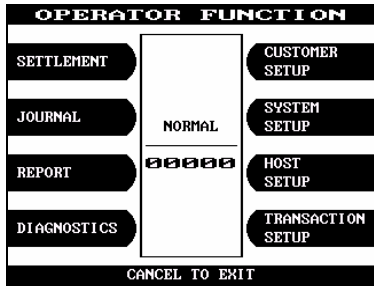

1) Select 'SYSTEM SETUP' in OPERATOR FUNCTION menu.

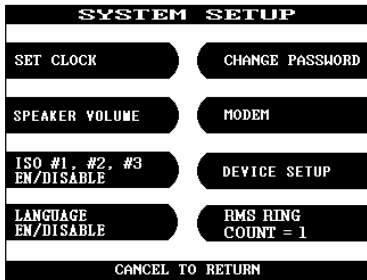

2) Select 'CHANGE PASSWORD' in 'SYSTEM SETUP' menu.

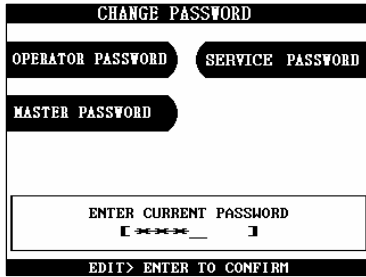

3) Select 'MASTER PASSWORD', 'OPERATOR PASSWORD' or 'SERVICE PASSWORD' in CHANGE PASSWORD. And enter the current Operator Password.

Fig. 5.44 CHANGE PASSWORD



4) Enter the new password you want to change.

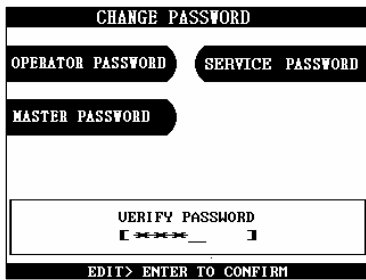

5) Enter the new password again.



6) The password will be changed.

Fig.5.44 CHANGE PASSWORD

Function Description

The CHANGE PASSWORD function is used to change the Operator Password. The factory default Operator Password is "222222". The factory default Master Password is "555555". The factory default Service Password is "111111".

5.7.5 Modem

5.7.5.1 MODEM SETUP

A) DIAL MODE

Accessing the DIAL MODE

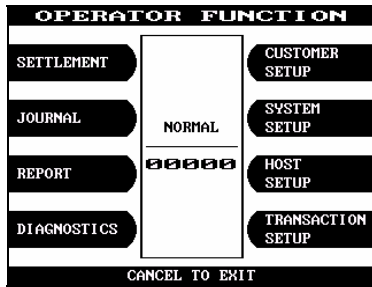

1) Select 'SYSTEM SETUP' in OPERATOR FUNCTION menu.

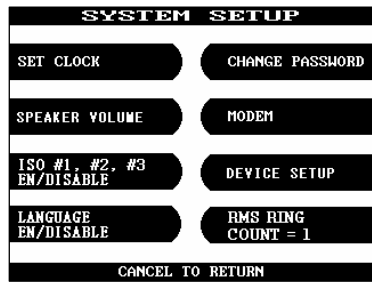

2) Select 'MODEM' in SYSTEM SETUP menu.

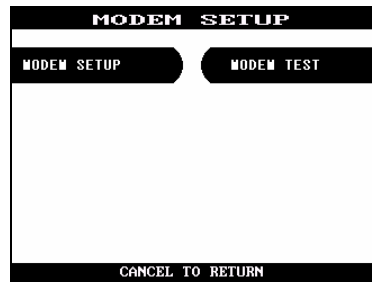

3) Select 'MODEM SETUP' in MODEM menu.

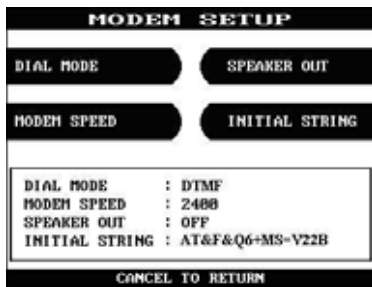

4) When DIAL MODE is pressed , it will be toggled to DTMF or PULSE.

Fig. 5.45 DIAL MODE

Function Description

The DIAL MODE function is used to change the Dial Mode to touch-tone mode(DTMF) or rotary mode(PULSE). Consult with the local phone company to determine which option is supported. The factory default is DTMF.

B) Modem speed

Accessing the MODEM SPEED

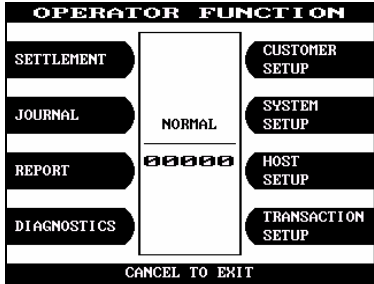

1) Select 'SYSTEM SETUP' in OPERATOR FUNCTION menu.

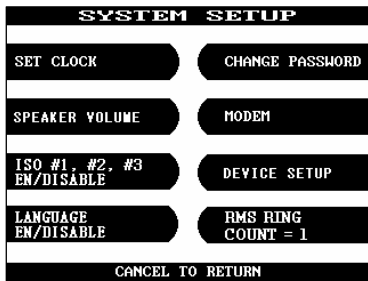

2) Select 'MODEM' in SYSTEM SETUP menu.

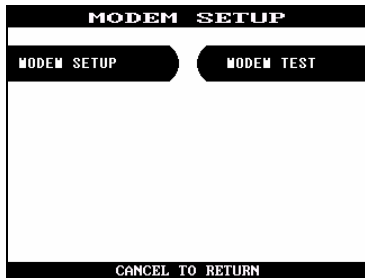

3) Select 'MODEM SETUP' in MODEM menu.

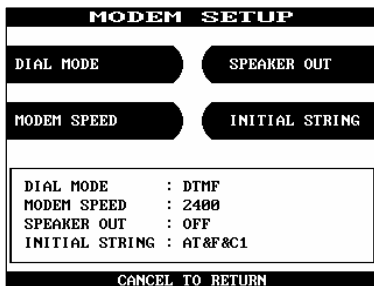

4) Select 'MODEM SPEED' in MODEM SETUP menu.

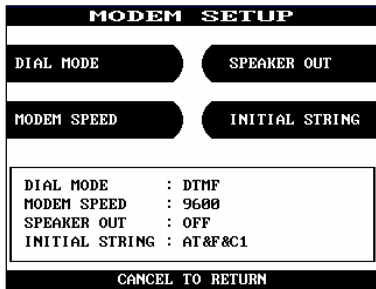

5) The Modem Speed can be changed from 300bps up to 56,000bps.

Fig. 5.46 MODEM SPEED

Function Description

The MODEM SPEED function is used to set the modem connecting speed with the host. The factory default speed is 2400bps.

C) Speaker out

Accessing the SPEAKER OUT

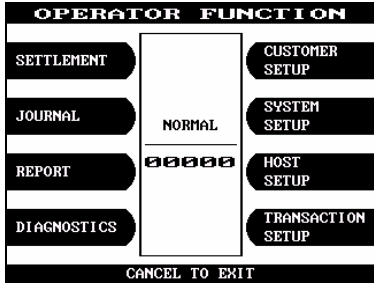

1) Select 'SYSTEM SETUP' in OPERATOR FUNCTION menu.

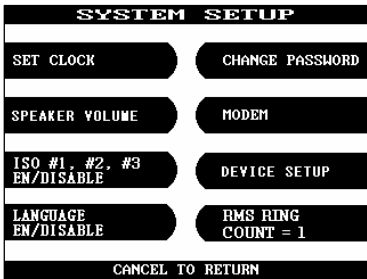

2) Select 'MODEM' in SYSTEM SETUP menu.

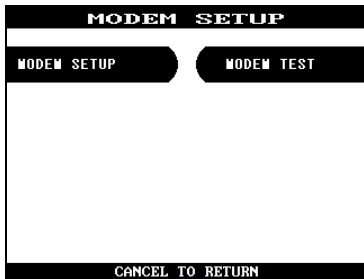

3) Select 'MODEM SETUP' in MODEM menu.

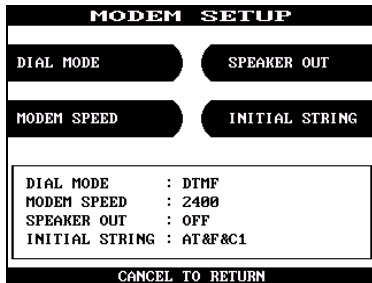

4) Select 'SPEAKER OUT' in MODEM SETUP menu. When you press the Speaker Out key, you can change speaker out on or off.

Fig. 5.47 SPEAKER OUT

Function Description

The SPEAKER OUT function is used to change the speaker out on or off at the modem dial connection. Service Personnel can check the dialing if it is normal or abnormal with this function in the speaker out on state. The factory default is OFF.

D) Initial string

Accessing the INITIAL STRING

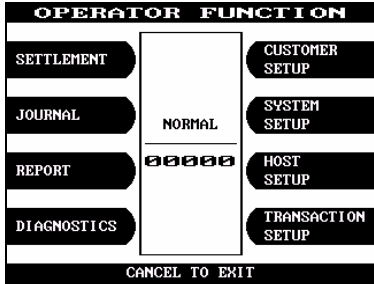

1) Select 'SYSTEM SETUP' in OPERATOR FUNCTION menu.

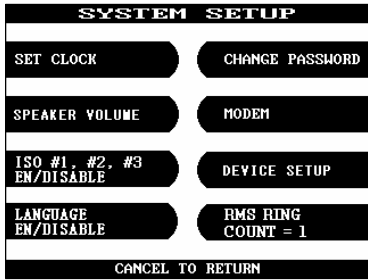

2) Select 'MODEM' in SYSTEM SETUP menu.

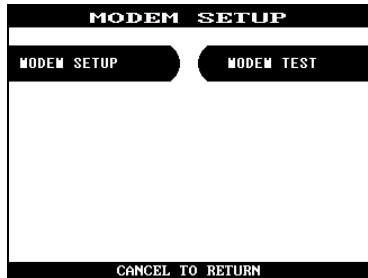

3) Select 'MODEM SETUP' in MODEM menu.

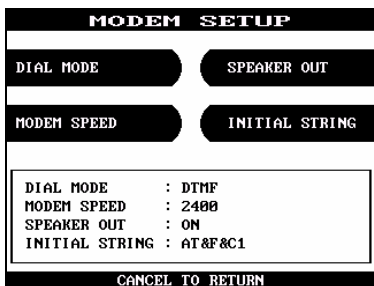

4) Select 'INITIAL STRING' in MODEM SETUP menu.

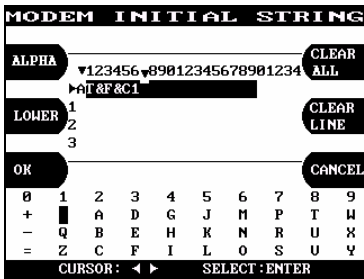

5) Enter the desired modem initial string. Please refer to 5.1 Basic Operation (How to use keypad).

Fig.5. 48 INITIAL STRING

Function Description

The INITIAL STRING function is used to edit the Modem Initial String when the special circumstances require a nonstandard Modem Initial String. The factory default is AT&F&Q6+MS=V22B. Before edit the Initial String, consult with Service Personnel.

5.7.5.2 Modem test

Accessing the MODEM TEST

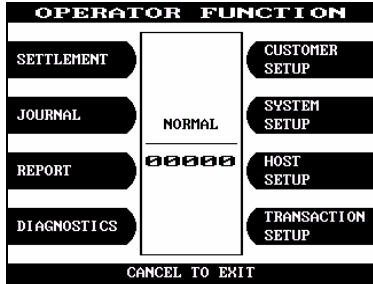

1) Select 'SYSTEM SETUP' in OPERATOR FUNCTION menu



2) Select 'MODEM' in SYSTEM SETUP menu. The modem will be started to test.

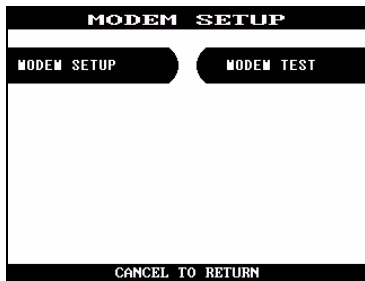

3) Select 'MODEM TEST' in MODEM menu.



4) If the GOOD message appears, press "ENTER".

Fig.5. 49 MODEM TEST

Function Description

The MODEM TEST function is used to perform the modem reset test. When the error is occurred, contact the Service Personnel.

5.7.6 RMS ring count

Accessing the RMS RING COUNT

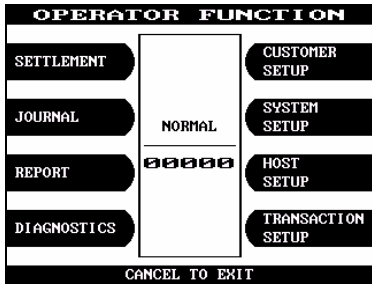

1) Select 'SYSTEM SETUP' in OPERATOR FUNCTION menu.

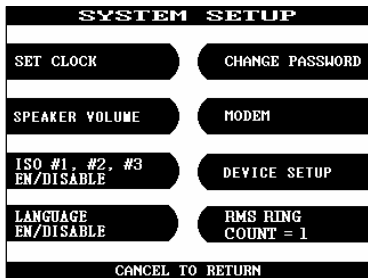

2) Select 'RMS RING COUNT' in SYSTEM SETUP menu.

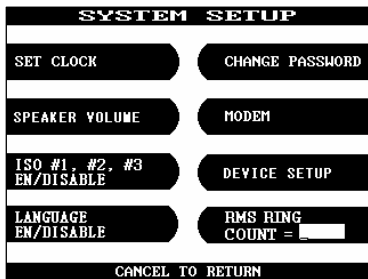

3) Enter RMS RING COUNT and press 'ENTER'.

Fig.5. 50 RMS RING COUNT

Function Description

When RMS calls to ATM, ATM will answer to RMS after ringing as RMS RING COUNT.

5.7.7 Speaker volume

Accessing the SPEAKER VOLUME

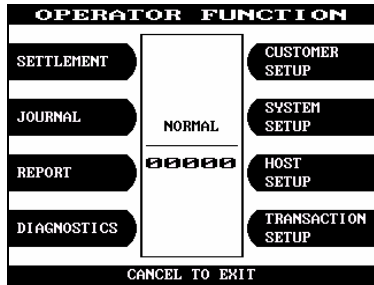

1) Select 'SYSTEM SETUP' in OPERATOR FUNCTION menu.

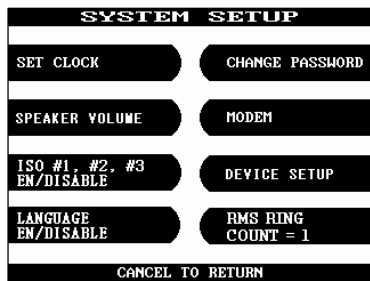

2) Select 'SPEAKER VOLUME' in SYSTEM SETUP menu.



3) Set your speaker volume with using < , > key.

Fig.5. 51 SPEAKER VOLUME

Function Description

The SPEAKER VOLUME function is used to set the speaker volume. With using < , > key an operator can hear the beep sound.

5.7.8 Device Setup

5.7.8.1 CDU Setup

A) Accessing CDU Setup

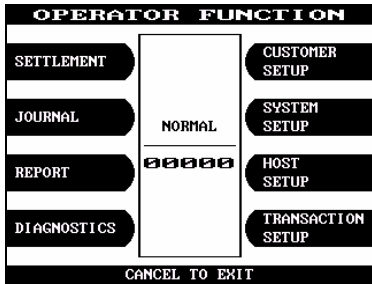

1) Select 'SYSTEM SETUP' in OPERATOR FUNCTION menu.

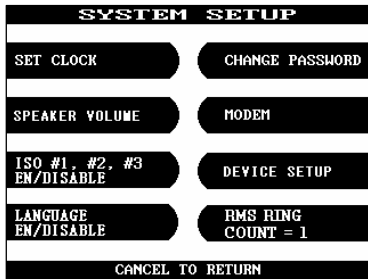

2) Select 'DEVICE SETUP' in SYSTEM SETUP FUNCTION menu.

Fig.5. 52 CDU Setup Main screen

B) Changing Country Code in CDU



1) Press 'COUNTRY' button. The country code of bottom side will be changed (USA, CANADA, and etc)

Fig.5. 53 Country Code Setup

C) Changing MB TYPE in CDU

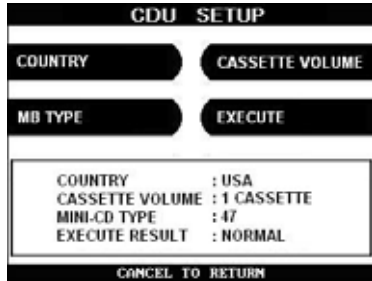

- 1) Press 'MB TYPE' button. The type of CDU will be changed. MB Type is for the front/rear service, shutter Existing or not and so on.

Fig. 5.54 MB Type Setup

D) Changing CASSETTE VOLUME in CDU



- 1) Press 'CASSETTE VOLUME' button. The number of cassette in CDU will be changed.

Fig.5. 55 Cassette Volume Setup

E) Submit and apply the setup value

After setup country code, CDU type and number of cassette, press 'EXECUTE' button to apply.

5.8 Host setup

The HOST SETUP function of the OPERATOR FUNCTION includes the following:

- KEY MANAGEMENT
 - MASTER KEY INDEX
 - CHECK MASTER KEY
 - EDIT MASTER KEY
 - SET MASTER KEY SERIAL NUMBER
- TELEPHONE NUMBER
- TERMINAL NUMBER
- HEALTH CHECK MESSAGE
- CONNECT TIMER 60 SECOND
- REMOTE MONITOR
 - RMS EN/DISABLE
 - RMS STATUS SEND EN/DISABLE
 - PASSWORD
 - REMOTE PHONE
 - MODEM SPEED
- ROUTING ID
- TRIAL DAY TOTAL

5.8.1 Key management

5.8.1.1 Master key index

Accessing the MASTER KEY INDEX

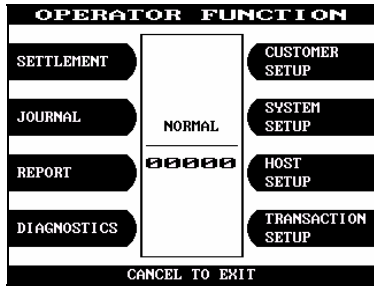

1) Select 'HOST SETUP' in OPERATOR FUNCTION menu.



2) Select 'KEY MANAGEMENT' in HOST SETUP menu.



3) Select the 'MASTER KEY INDEX' in the KEY MANAGEMENT menu. Enter the Master Key Index.

Fig. 5.56 Master Key Index

Function Description

The MASTER KEY INDEX function is used to set the Master Key Index. The range is 0 to 15.

5.8.1.2 Check master key

Accessing the CHECK MASTER KEY

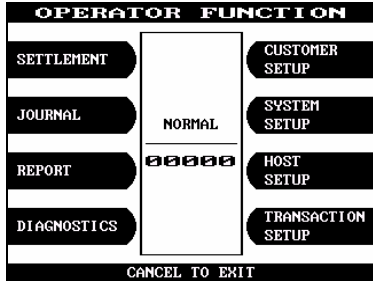

1) Select 'HOST SETUP' in OPERATOR FUNCTION menu.



2) Select 'KEY MANAGEMENT' in HOST SETUP menu.



3) Select 'CHECK MASTER KEY' in KEY MANAGEMENT menu.

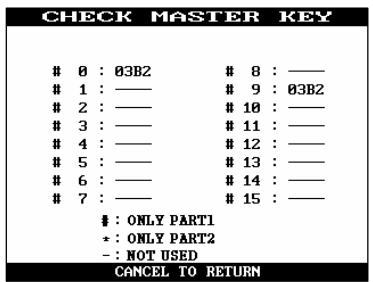

4) It will display the check sum of all injected master key.

Fig. 5.57 Check Master Key

Function Description

The CHECK MASTER KEY function is used to display the check sum of all injected Master Key. The master key which is displayed as “_____” means it is in empty state.

5.8.1.3 Edit master key

Accessing the EDIT MASTER KEY

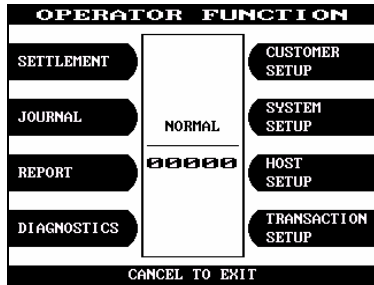

1) Select 'HOST SETUP' in OPERATOR FUNCTION menu.



2) Select 'KEY MANAGEMENT' in HOST SETUP menu.



3) Select 'EDIT MASTER KEY' in KEY MANAGEMENT menu.



4) Select 'MASTER KEY PART1' or 'MASTER KEY PART2' in EDIT MASTER KEY menu.

Fig. 5.58 Edit Master Key

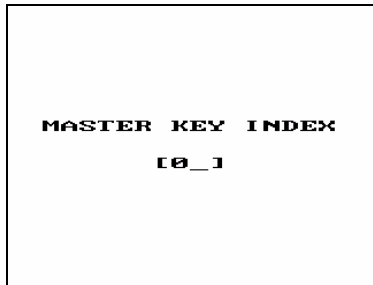

5) Enter the master key index.



6) Enter the Master Key PART 1.



7) Verify the Master Key PART 1.



8) Enter the Master Key PART 2

Fig.5. 58 Edit Master Key

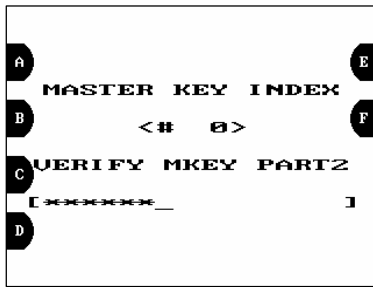

9) Verify the Master Key PART 2.



10) After inputting the Master Key, the check sum will be displayed. Press "ENTER" after confirming the check sum.

Fig.5. 58 Edit Master Key

Function Description

The EDIT MASTER KEY function is used to enter the Master Key.

5.8.1.4 Set master key serial number

Accessing the SET MASTER KEY SERIAL NUMBER

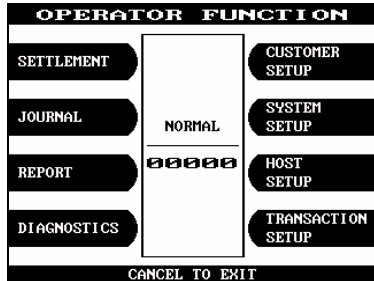

1) Select 'HOST SETUP' in OPERATOR FUNCTION menu.



2) Select 'KEY MANAGEMENT' in HOST SETUP menu.



3) Select 'MASTER KEY SERIAL NUMBER' in KEY MANAGEMENT menu. And insert serial number.

Fig.5. 59 MASTER KEY SERIAL NUMBER

Function Description

The MASTER KEY SERIAL NUMBER function is used to insert the ATM machine number for RMS (Mono : 8890000001 ~ 8899999999).

5.8.2 Telephone number

Accessing the TELEPHONE NUMBER

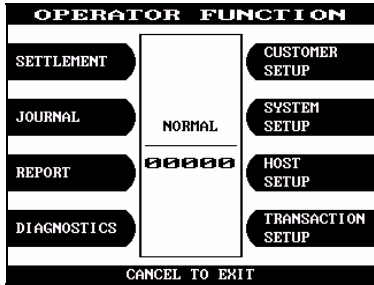

1) Select 'HOST SETUP' in OPERATOR FUNCTION menu.



2) Select 'TELEPHONE NUMBER' in HOST SETUP menu.

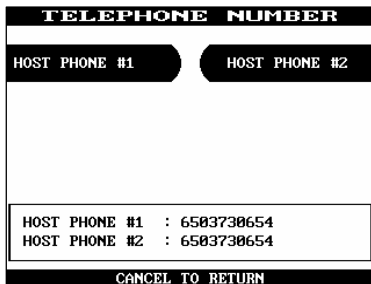

3) Select 'HOST PHONE #1' in TELEPHONE NUMBER menu.

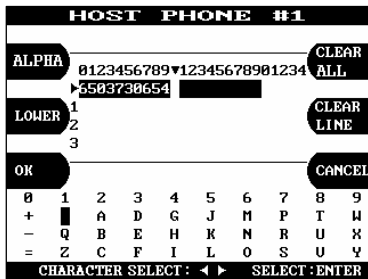

4) Enter Host Phone number 1. Please refer to 5.1 Basic Operation(How to use keypad).

Fig.5. 60 Telephone Number

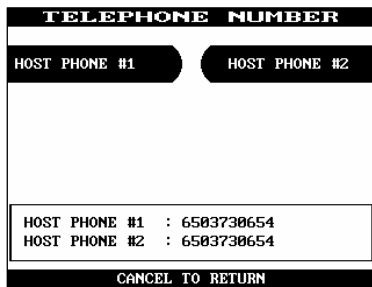

5) Select 'HOST PHONE #2' in TELEPHONE NUMBER menu.

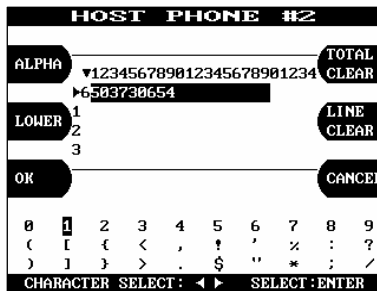

6) Enter Host Phone number 2. Please refer to 5.1 Basic Operation(How to use keypad).

Fig.5. 60 Telephone Number

Function Description

The TELEPHONE NUMBER function is used to enter the Primary Telephone Number and the Back-up Telephone number of the host.

5.8.3 TERMINAL NUMBER

Accessing the TERMINAL NUMBER

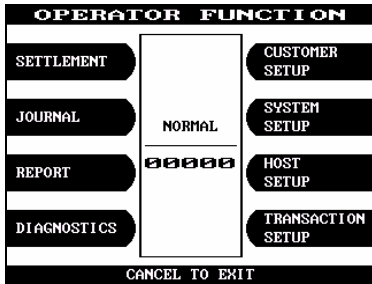

1) Select 'HOST SETUP' in OPERATOR FUNCTION menu.



2) Select 'TERMINAL NUMBER' in HOST SETUP menu.

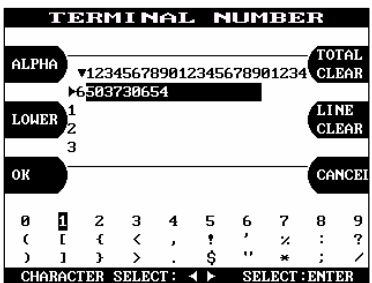

3) Enter the Terminal Number. Please refer to 5.1 Basic Operations. (How to use keypad)

Fig. 5.61 TERMINAL NUMBER

Function Description

The TERMINAL NUMBER is included in transaction message to host.

5.8.4 Health Check Message

Accessing the HEALTH CHECK MESSAGE

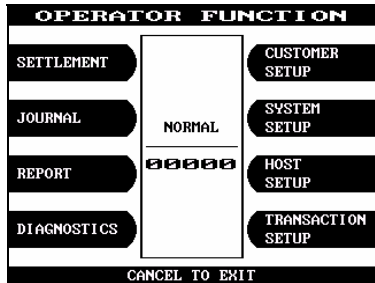

1) Select 'HOST SETUP' in OPERATOR FUNCTION menu.



2) Select 'HEALTH CHECK MESSAGE' in HOST SETUP menu.

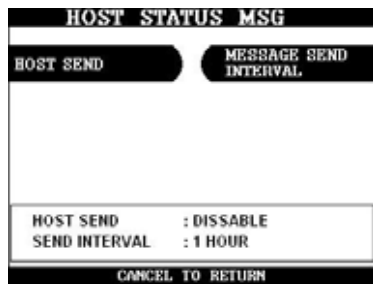

3) Select 'HOST SEND' and 'MESSAGE SEND INTERVAL' in HEALTH CHECK MESSAGE menu.

Fig.5. 62 HEALTH CHECK MESSAGE

Function Description

The HOST SEND function is used to set HOST SEND MESSAGE to be enabled or disabled. The MESSAGE SEND INTERVAL function is used to set INTERVAL TIME.

Connect timer 60 second

Accessing the CONNECT TIMER 60 SECOND

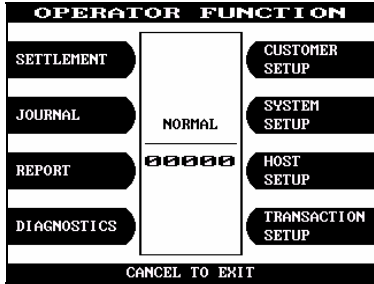

- 1) Select 'HOST SETUP' in OPERATOR FUNCTION menu.



- 2) Press 'CONNECT TIMER 60 SECOND' in HOST SETUP menu. After entering the timer parameter with PIN pad, press "ENTER".

Fig.5. 63 CONNECT TIMER

Function Description

The CONNECT TIMER 60 SECOND function is used to set the waiting timer during connecting to the host. After powering on the machine, the machine will try to connect to the host. However when the machine fails to connect to the host, it will wait for a while and will attempt to connect again. This function is used to set the waiting time. The factory default is 60 seconds.

5.8.6 Remote monitor

5.8.6.1 RMS EN/DISABLE

Accessing the RMS EN/DISABLE

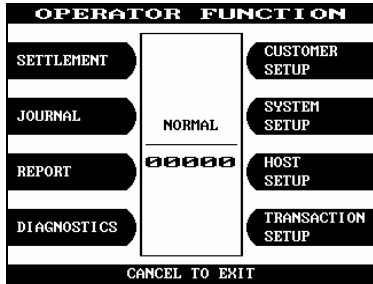

1) Select 'HOST SETUP' in OPERATOR FUNCTION menu.



2) Select 'REMOTE MONITOR' in HOST SETUP menu.



3) Select 'RMS EN/DISABLE' in REMOTE MONITOR menu.

Fig.5. 64 RMS EN/DISABLE



4) When you press RMS EN/DISABLE key, it will be changed to be enabled or disabled.

Fig.5. 65 RMS EN/DISABLE

Function Description

The RMS(Remote Monitoring System) EN/DISABLE function is used to connect with the RMS mode in enabled or in disabled. The factory default is disabled.

5.8.6.2 RMS status send en/disable

Accessing the RMS STATUS SEND EN/DISABLE

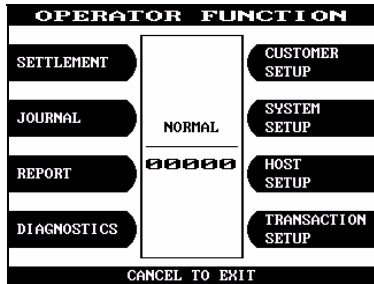

1) Select 'HOST SETUP' in OPERATOR FUNCTION menu.



2) Select 'REMOTE MONITOR' in HOST SETUP menu.



3) Select 'RMS STATUS SEND EN/DISABLE' in REMOTE MONITOR menu.

Fig.5. 66 RMS STATUS SEND EN/DISABLE



4) When you press the RMS STATUS SEND EN/DISABLE key, it will be changed to be enabled or disabled.

Fig. 5.67 RMS STATUS SEND EN/DISABLE

Function Description

The RMS(Remote Monitoring System) STATUS SEND EN/DISABLE function is used to send NH 2100T status to the RMS when NH 2100T status is changed. The factory default is disabled.

5.8.6.3 Password

Accessing the PASSWORD

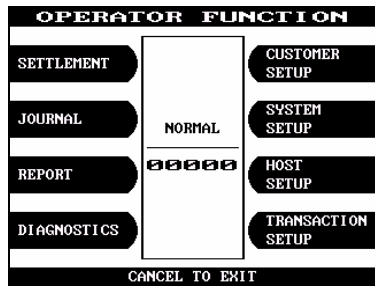

1) Select 'HOST SETUP' in OPERATOR FUNCTION menu.



2) Select 'REMOTE MONITOR' in HOST SETUP menu.



3) Select 'PASSWORD' in REMOTE MONITOR menu.

Fig. 5.68 PASSWORD

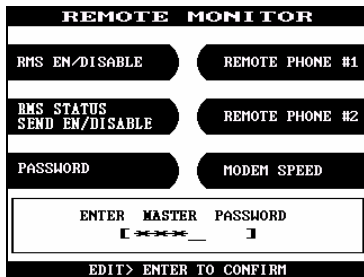

4) Enter MASTER Password.

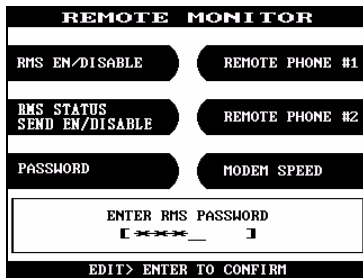

5) Enter new RMS Password.

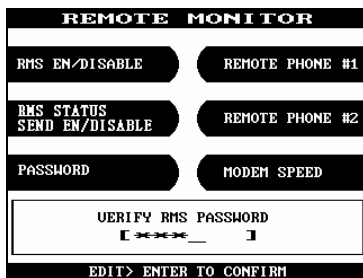

6) Enter new RMS Password again.

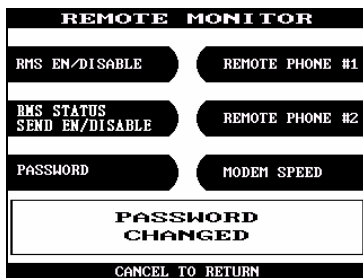

7) The password will be changed.

Fig. 5.69 PASSWORD

Function Description

The PASSWORD function is used to set the RMS password to connect to NH 2100T from RMS. The factory default RMS Password is "333333".

5.8.6.4 Remote phone

Accessing the REMOTE PHONE

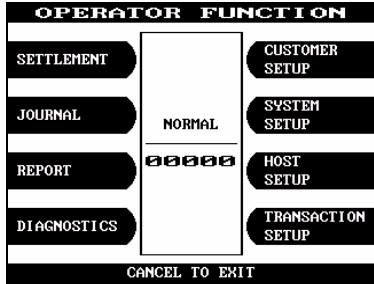

1) Select 'HOST SETUP' in OPERATOR FUNCTION menu.



2) Select 'REMOTE MONITOR' in HOST SETUP menu.



3) Select 'REMOTE PHONE #1' in REMOTE MONITOR menu.

Fig.5. 70 REMOTE PHONE

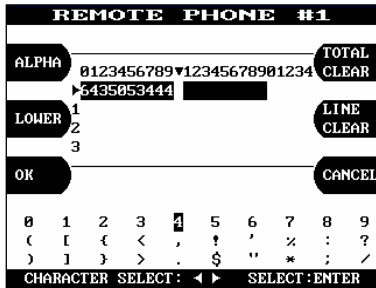

4) Enter the first Remote Phone number.
Please refer to 5.1 Basic Operations.
(How to use keypad)



5) Select 'REMOTE PHONE #2' in REMOTE MONITOR menu.

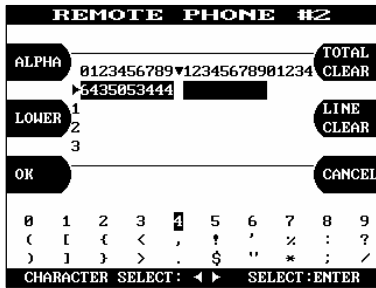

6) Enter the second Remote Phone number 2.
Please refer to 5.1 Basic Operations.
(How to use keypad)

Fig. 5.70 REMOTE PHONE

Function Description

The REMOTE PHONE function is used to input the RMS Primary Telephone Number and the Back-up Telephone Number.

5.8.6.5 Modem speed

Accessing the MODEM SPEED

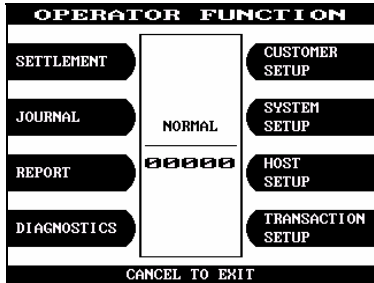

1) Select 'HOST SETUP' in OPERATOR FUNCTION menu.



2) Select 'REMOTE MONITOR' in HOST SETUP menu.



3) When you press MODEM SPEED key, the speed will be changed to 300bps up to 56,000bps.

Fig. 5.71 MODEM SPEED

Function Description

The MODEM SPEED function is used to set the Modem speed of RMS and NH 2100T.

5.8.7 Routing ID

Accessing the ROUTING ID

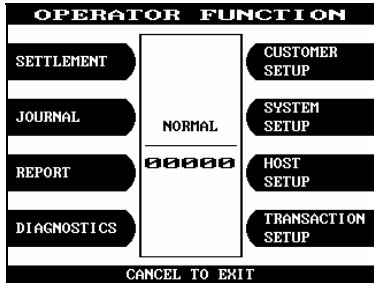

1) Select 'HOST SETUP' in OPERATOR FUNCTION menu.



2) Select 'ROUTING ID' in the HOST SETUP menu.

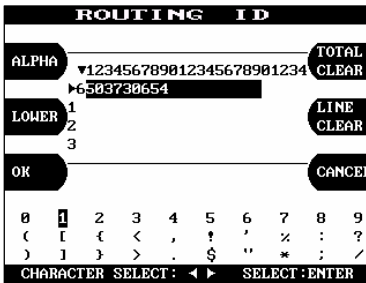

3) Enter the desired Routing ID number. Please refer to 5.1 Basic Operations. (How to use keypad)

Fig. 5.72 ROUTING ID

Function Description

The ROUTING ID function is used to set the Routing ID Number of NH 2100T.

5.8.8 Trial Day Total

Accessing the TRIAL DAY TOTAL

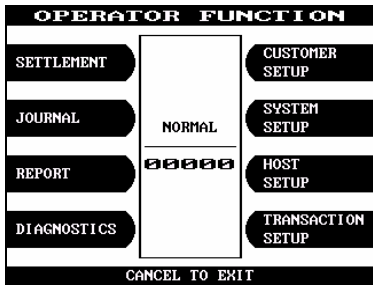

1) Select 'HOST SETUP' in OPERATOR FUNCTION menu.



2) Select 'TRIAL DAY TOTAL' in HOST SETUP menu.



3) If you press 'TRIAL DAY TOTAL' button, it will be changed to be enabled or disabled.



4) If you press 'SET LOGGING TIME' button, it will be set to the automatic close time.

Fig.5.73 TRIAL DAY TOTAL

Function Description

The TRIAL DAY TOTAL function is used to run automatic action of DAY TOTAL.

5.9 Transaction Setup

The TRANSACTION SETUP function of the OPERATOR FUNCTION includes the following:

DISPENSE LIMIT
DENOMINATION
FAST CASH
CURRENCY LOW CHECK

5.9.1 Dispense limit

Accessing the DISPENSE LIMIT

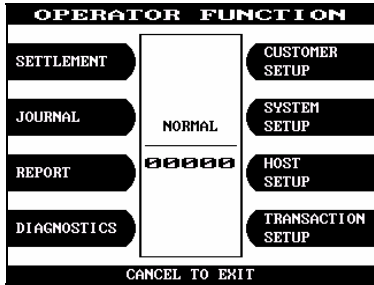

1) Select 'TRANSACTION SETUP' in OPERATOR FUNCTION menu.



2) Enter the desired dispense limit after pressing DISPENSE LIMIT button.

Fig. 5.74 DISPENSE LIMIT

Function Description

The DISPENSE LIMIT function is used to set the maximum amount of notes that can be dispensed per transaction. The maximum amount must be multiples of denomination. And the maximum number of notes must not be over totals of 40 notes. The factory default is \$300.

5.9.2 Denomination

Accessing the DENOMINATION

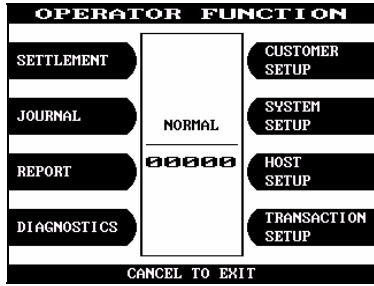

1) Select 'TRANSACTION SETUP' in OPERATOR FUNCTION menu.



2) Select 'DENOMINATION' in TRANSTATION SETUP.

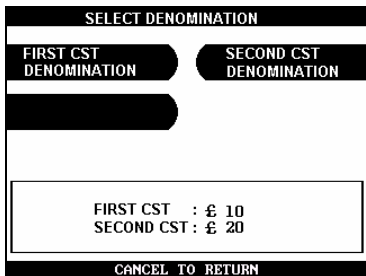

3) Enter the desired denomination of bills after pressing DENOMINATION button.

Fig. 5.75 DENOMINATION

Function Description

The DENOMINATION function is used to set the denomination of notes to be set in the cassette. The valid denomination is \$20, \$40, \$60, \$80, \$100 and \$120. The factory default is \$10 (and \$20 : 2 cassettes).

5.9.3 Fast cash

Accessing the FAST CASH

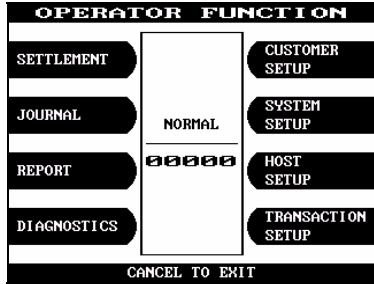

1) Select 'TRANSACTION SETUP' in OPERATOR FUNCTION menu.



2) Select 'FAST CASH' in TRANSACTION SETUP menu.



3) You can change the fast cash amount LB0 to LB2 and RB0 to RB2 with press the button.

Fig.5.76 FAST CASH

Function Description

The FAST CASH function is used to set the cash amount, which is to be displayed on the FAST CASH screen. The maximum amount must be less than the Dispensable Limit. The factory default is \$20, \$40, \$60, \$80, \$100 and \$120.

5.9.4 Currency low check

Accessing the CURRENCY LOW CHECK

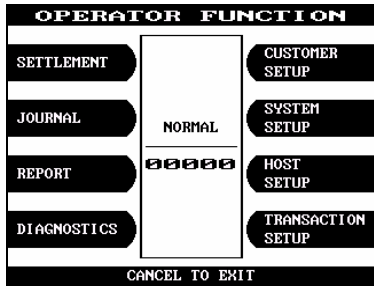

1) Select 'TRANSACTION SETUP' in OPERATOR FUNCTION menu.



2) If you want to enable Low Currency Check function, press CURRENCY LOW CHECK button once.

Fig.5.77 CURRENCY LOW CHECK

Function Description

The CURRENCY LOW CHECK function is used to set the cassette low level detection. If this function is enabled, the machine will be changed to "OUT OF SERVICE" when notes are not enough in the cassette. The factory default is in disable.

6. Appendix

6. Appendix

A. SUMMARY OF SPECIFICATION

(sec : second)

Item	Description	Specification		
		Default	Option	
Product	Type	Through The Wall		
	Maintenance	Rear Door Access		
Control Electronics	CPU	i80186EB		
	Serial Ports	5 ports (extended 2 ports)		
	Memory	FLASH	512KB	
		NVRAM	128KB	
SRAM		256KB		
Software	Operating System	Real Time OS		
	Emulator	ISO 8583		
	Auxiliary Functions	On screen advertisement, Remote monitoring utility		
Communication	External Communication	Dial-up		
Display	Monitor	5.7" Mono LCD, Transreflective (sun viewable)		
	Resolution	320 X 240		
Input Key	Encrypted PIN pad	Braille	PIN Pad with ADA	VISA lab certified
		Encryption	T-DES compliant	
	Menu Keys	2 x 4		
Cash Dispenser	Type	Tray with shutter(Spread)		
	Denomination	1 Denomination		
	Max. number of bills dispensed	40 notes/transaction		
	Number of cassettes	1,000 bills		
	Discharging speed	7 notes/sec		
	Reject	Method	Note by note collection	
Box capacity		200 notes with key lock		
Card Reader	Type	Dip Type		
	Magnetic card	ISO 1,2		
	Smart card reader	Optional		
Receipt Printer	Printing method	Thermal		
	Width of receipt	3 1/8"(80.00mm)		
	Printing Speed	3.9 "/sec (100 mm/sec)		
	Capacity of receipt roll	2,000 Transactions		
	Setting method	Semi-auto setting		
Journal	Type	Electronic Journal		
Safety	Certification	UL291 Business Hour		
	Locks	Electronic lock		
Power Supply	Voltage	AC 110/220	Selectable	
Dimension	Width x Depth x Height	23.75x28.5x33.0 inches (603x724x838 mm)		
	Weight	283 lbs. (129 Kg)		

B. BILL CONDITIONS

B-1 Acceptable condition

- Bill which is very clean and can readily be recognized as a true bill

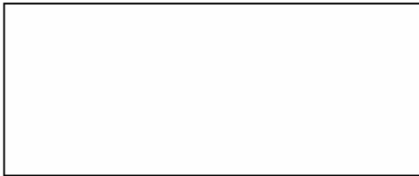

- Bill has sufficient life or sizing to be handled easily



- Bill which can be manually held straightly when one end is held by a hand and the bill is slightly curved vertically

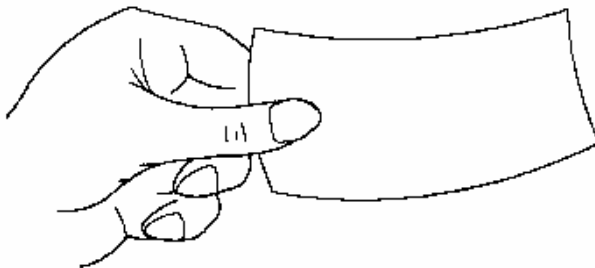

B-2 Unacceptable condition

- Bill having serious wrinkles, torn or broken section wherein paper fiber is broken and separation begins
 - ✓ Wrinkle

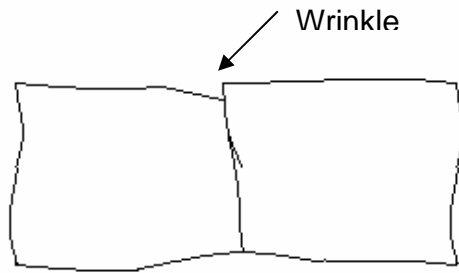

- ✓ Torn

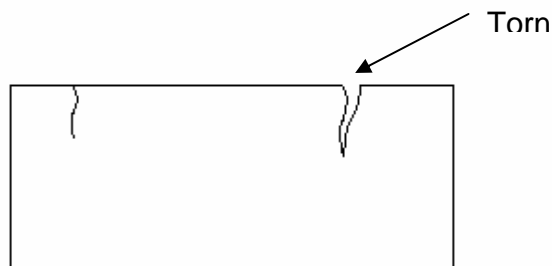

- ✓ Broken section

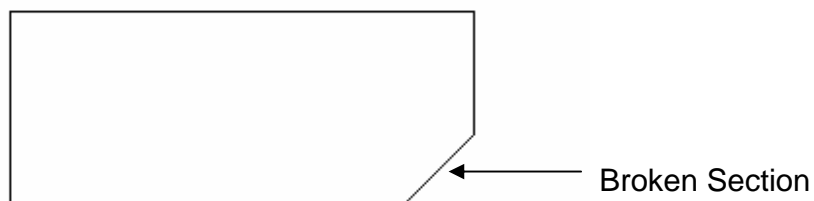

- Bill having adequate life or sizing, but stained seriously

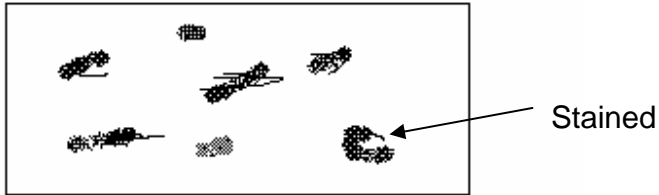

- Bill with holes (Perforated bill)

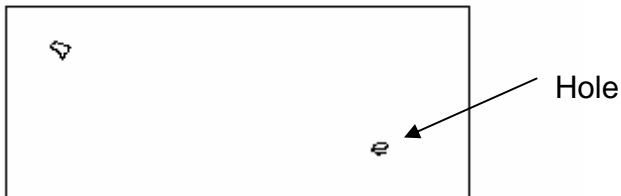

- Bill ragged and cannot be held straightly when one end is supported by a hand

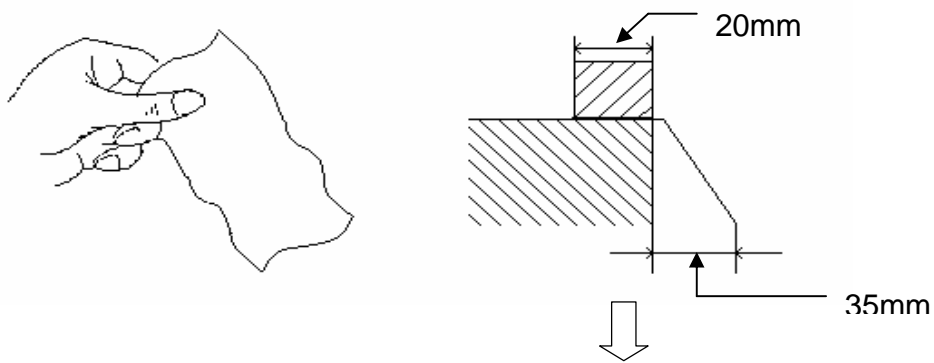

When the bill is held by 20mm and the straightness of the bill is 35mm or less, it cannot be used

- Bill with cellophane tape, scotch tape, etc

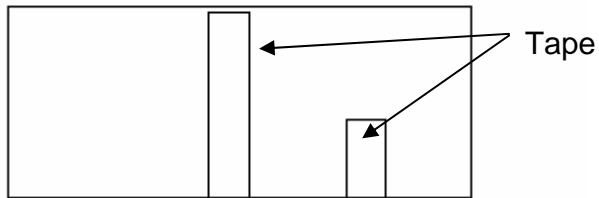

- Bill with folds

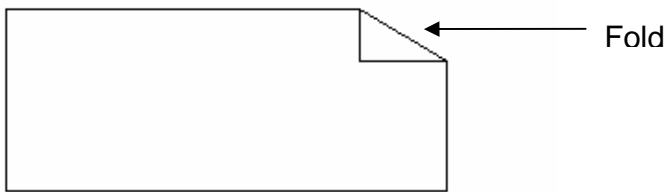

- Gradually curved bill (bills tied by hand seal, etc)

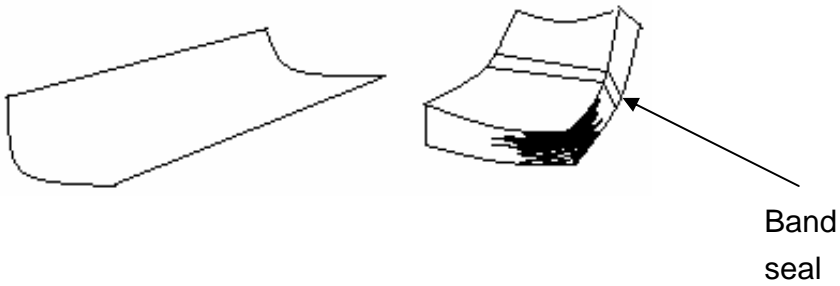

- Bill with folded lines

- ✓ Case 1

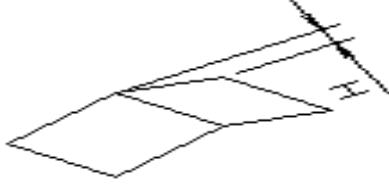

- ✓ Case 2



- ✓ Case 3

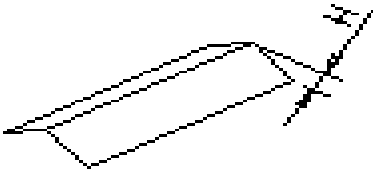

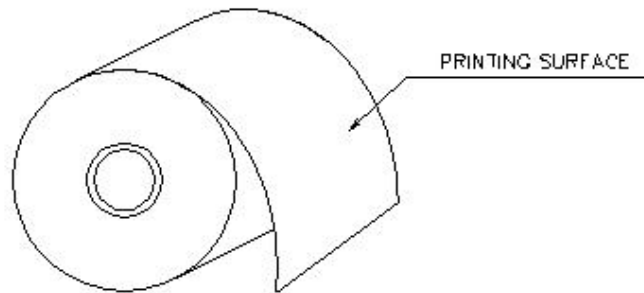
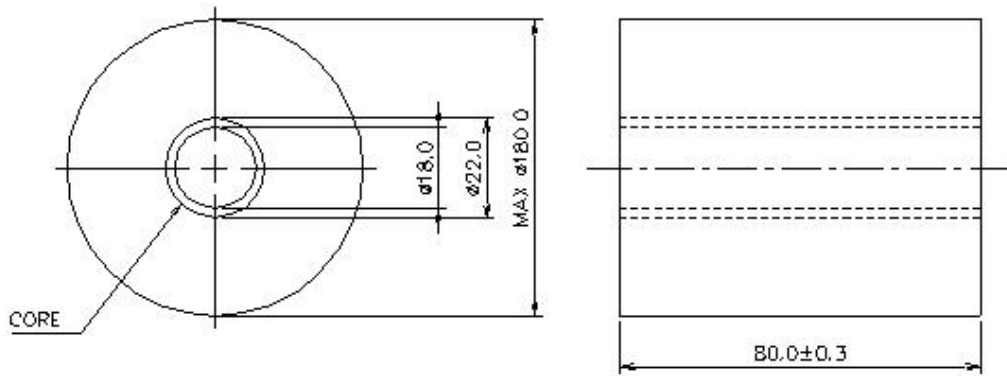

Bill distortion should not exceed 10 mm

C. RECEIPT PAPER SPECIFICATIONS

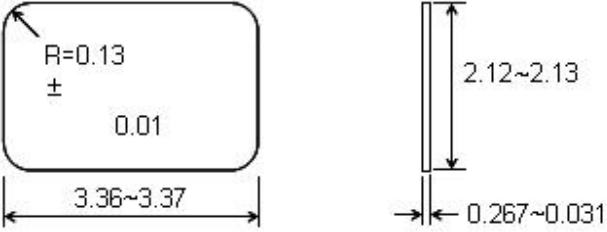

- All measurements are in mm.

D. MAGNETIC CARD SPECIFICATIONS

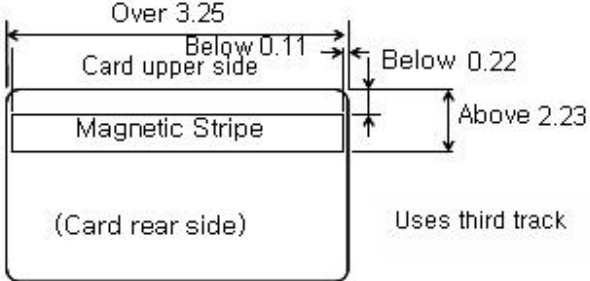
Item	ISO Card (Unit : Inch)
Length	 <p>Diagram showing ISO card dimensions: Length is 2.12~2.13 inches, width is 3.36~3.37 inches. Corner radius is R=0.13 ± 0.01 inches. Thickness is 0.267~0.031 inches.</p>
Card Bending	 <p>Diagram showing card bending specification: Below 0.079 inches.</p>
Magnetic Stripe Position	 <p>Diagram showing magnetic stripe position: Card upper side, Magnetic Stripe, (Card rear side). Dimensions: Over 3.25 inches, Below 0.11 inches, Below 0.22 inches, Above 2.23 inches. Uses third track.</p>

E. ERROR CODE TABLE

ERROR CODES	ERROR DESCRIPTION	CORRECTIVE ACTION
00000	Normal Status	Normal Status
20001	Cash cassette is not properly set.	Set the cash cassette properly.
20002	Cash cassette empty.	Load the cash into the cash cassette and set the number of bills.
20003	Reject Bin full.	Empty the Reject Bin.
20004	Security Door open.	Close the Security Door.
20010	Receipt paper jam.	Clear the jammed paper.
20012	Receipt Printer feed lever open.	Close the feed lever.
20013	Receipt paper empty.	Load the receipt paper.
20014	Receipt Printer thermal head over heated.	Call your service personnel.
20015	Note detected.	Clear jammed notes or call your service personnel.
Axxx1	Receipt Printer feed lever open.	Close the feed lever.
Axxx2	Receipt Printer thermal head over heated.	Call your service personnel.
Axxx3	Receipt paper jam.	Clear the jammed paper.
Axxx4	Receipt paper empty.	Load the receipt paper.
Axxx5	Receipt paper setting error.	Clear the paper and reload.
Axxx6	Receipt Printer DIP switch error.	Call your service personnel.
Axxx7	Receipt Printer Lever Opened	Check sensor, cable connection and connector
Axxx8	Receipt Printer cutter error.	Check paper jam, or call your service personnel.
ADNxx	Receipt Printer connection failure.	If error is not recovered, call your service personnel.
C0001 ~ C002F	CDU sensor blocked.	Clear the note path or call your service personnel.
C0030	CDU main motor failure.	Call your service personnel.
C0031	CDU gate solenoid echo error.	Call your service personnel.
C0032	CDU outlet solenoid echo error.	Call your service personnel.
C0033	CDU encoder error.	Call your service personnel.
C0032	CDU double detect module failure 1	Call your service personnel.
C0033	CDU double detect module failure 2	Call your service personnel.
C0034	Note detected (outlet sensor)	Call your service personnel.
C0035	CDU double detect module failure 3	Call your service personnel.
C0036		Clear the note from the outlet sensor.
C0037		Call your service personnel.

ERROR CODES	ERROR DESCRIPTION	CORRECTIVE ACTION
C0040 C0041 C0042	Cash cassette taken out during dispense Dispensing error Note jam	Set the cash cassette properly Call your service personnel Clear jammed notes or call your service personnel.
C0043	Over 10 notes has been rejected per 1 transaction.	Check notes or call your service personnel.
C0044	Over 5 notes has been rejected continuously.	Check notes or call your service personnel.
C0045	Too many notes dispensed continuously.	Check notes and note set status.
C0046	CDU hardware failure	Call your service personnel.
C0047	1st Cassette Misfeed	Check notes and note set status.
C0048	Wrong count.	Check notes and note set status or Call your service personnel.
C004A	Note jam.	Call your service personnel.
C004B	Many notes too close.	Call your service personnel.
C004C	Wrong count	Check notes or note set status or call your service personnel
C004D	Cash cassette is not properly set	Set the cash cassette properly
C004E	Wrong count	Call your service personnel
C004F	Wrong count(over dispensed)	Call your service personnel
C0050	Power failed during dispensing	Check journal for last transaction
C0051	Too many notes requested	Call your service personnel
C0052	Note detected(CS1A, CS1B)	Clear jammed notes or
C0053	CDU double detect module failure 4	Call your service personnel
C0055	Long note detected(outlet sensor)	Call your service personnel
C005B	2nd Cassette Misfeed	Check notes and note set status.
C009F	3rd Cassette Misfeed	Check notes and note set status.
CDNxx	CDU connection failure.	If error is not recovered, call your service personnel.
Dxx01	Modem reset failure	Call your service personnel.
Dxx02	Reversal failure	Call your service personnel
D0011 ~ D0099	Transaction Error responded by Host	Check transaction history in Host and try again
D009A ~	Communication Error	Check phone line status Check modem

ERROR CODES	ERROR DESCRIPTION	CORRECTIVE ACTION
E0001 E0002 E0003 E0004 E0005	RMS port failure RMS response timeout RMS modem failure RMS no dial tone RMS retry over	Call your service personnel. Call your service personnel. Call your service personnel. Call your service personnel. Call your service personnel.
F0001 F0002	Number of Bill is not inputted Surcharge Owner is not inputted in Surcharge Enable	Input number of Bill Input Surcharge Owner
F0003	Surcharge Amount is not inputted in Surcharge Enable	Input Surcharge Amount
F0004	Refresh timer is not inputted in Advertisement Enable	Input Refresh timer
F0005	Advertisement text is not inputted in Advertisement Enable	Input Advertisement text
F0006	Error in Dispense Limit setting	Check Dispense Limit and reset
F0007	Error in inputting Note Currency	Check note currency and reset
F0008	Error in Fast Cash setting	Check Fast Cash Value and reset
F0009	Master Key Index invalid (0 <= MKEY Index <= 15)	Check Master Key and reset
F000A	Master Key Empty	Input Master Key
F000B	Host Phone Number is not inputted	Input Host Phone Number
F000C	Error Retry Timer is not inputted	Input Error Retry Timer
F000D	RMS Password is not inputted in RMS Enable	Input RMS Password
F000E	RMS Phone Number is not inputted in RMS Enable	Input RMS Phone Number
F000F	Terminal Number is not inputted	Input Terminal Number
F0010	Routing ID is not inputted	Input Routing ID
F0011	Master Key Serial Number is not inputted	Input Master Key Serial Number
F0012	Non-Cash Type text is not in/out (only MB-2100, 2200)	Input Non-Cash Type
F0013	Parameter is not properly set	Input Non-Cash Value
F0014	NVRAM Failure	Check Battery and Battery Plug Change Main Board